

INSTRUCTION MANUAL

1/10 Scale 4WD RC Nitro & Electric Powered Car



Spirit N1/N2

RH1006 - N1 (Single Speed)

RH1007 - N2 (Two Speed)



Spirit EBD/EBL

RH1016 - EBD (Brushed)

RH1017 - EBL (Brushless)

Index

Spirit N1/N2 Specification-----	P2
Assembly Diagrams-----	P3-P7
Shocks & Chassiss Assembly-----	P3
Front & Rear Assembly-----	P4
Engine & Central Tranmssion Assembly-----	P5
Others-----	P6
Swar bar upgrade-----	P7
Assembly Steps-----	P8
Spirit EBD/EBL Specification-----	P9
Assembly Diagrams-----	P10-P11
Chassiss & Motor & Steering Assembly-----	P10
Swar bar upgrade-----	P11
Assembly Steps-----	P12
Part List-----	P13-P21
Part List-----	P13-P20
Upgrade Part List-----	P21

RH1006 SPIRIT N1 (Single Speed)

RH1006 Specs. :

1. Length: 415 mm
2. Width: 255 mm
3. Height: 142 mm
4. Wheelbase: 275/280 mm
5. Gear Ratio: 9.1:1
6. Tyre: $\phi 88 \times 34$ mm (FRONT)
 $\phi 88 \times 39$ mm (REAR)
7. Weight: 1840 g (SPIRIT N1)

Standard Equipments:

1. Steering Servo: 3kg/cm
2. Throttle Servo: 3kg/cm
3. Engine: G0.18 or SH.18
4. Radio: 2CH AM

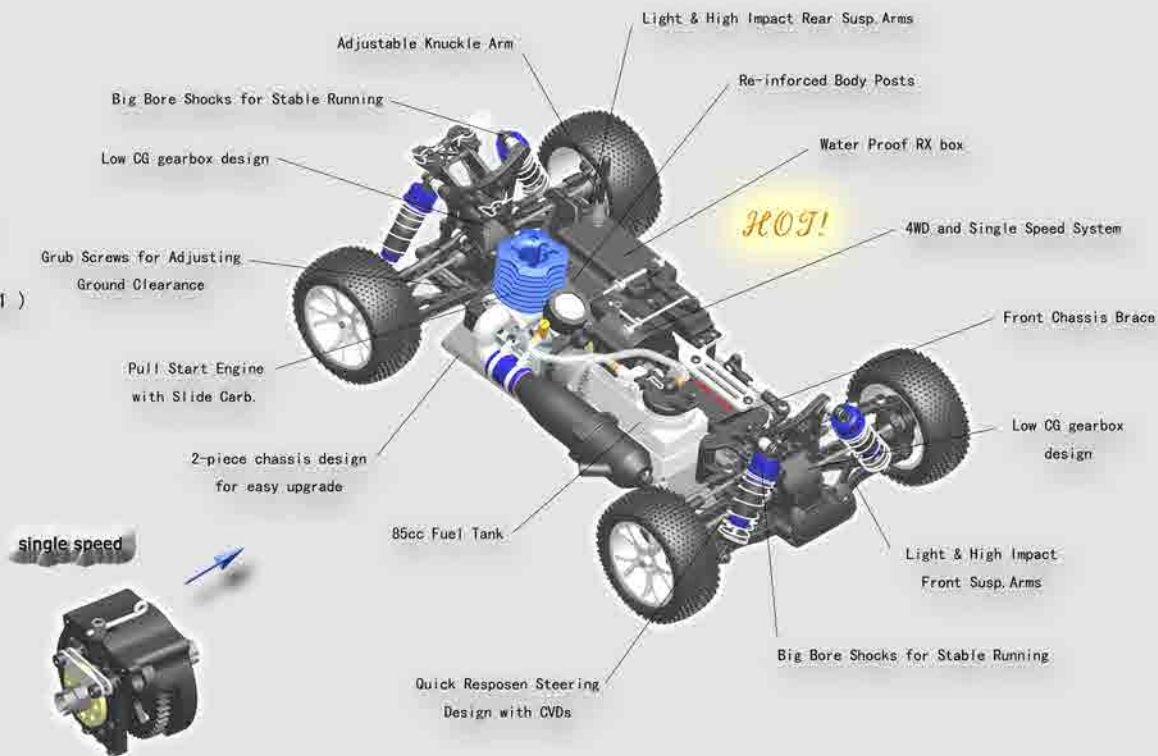

RH1007 SPIRIT N2 (Two Speed)

RH1007 Specs. :

1. Length: 415 mm
2. Widthe: 255 mm
3. Height: 142 mm
4. Wheelbase: 275/280 mm
5. Gear Ratio: 6.1:1 (H)
9.1:1 (L)
6. Tyre: $\phi 88 \times 34$ mm (FRONT)
 $\phi 88 \times 39$ mm (REAR)
7. Weight: 1900 g (SPIRIT N2)

Standard Equipments:

1. Steering Servo: 3kg/cm
2. Throttle Servo: 3kg/cm
3. Engine: G0.18 or SH.18
4. Radio: 2CH AM

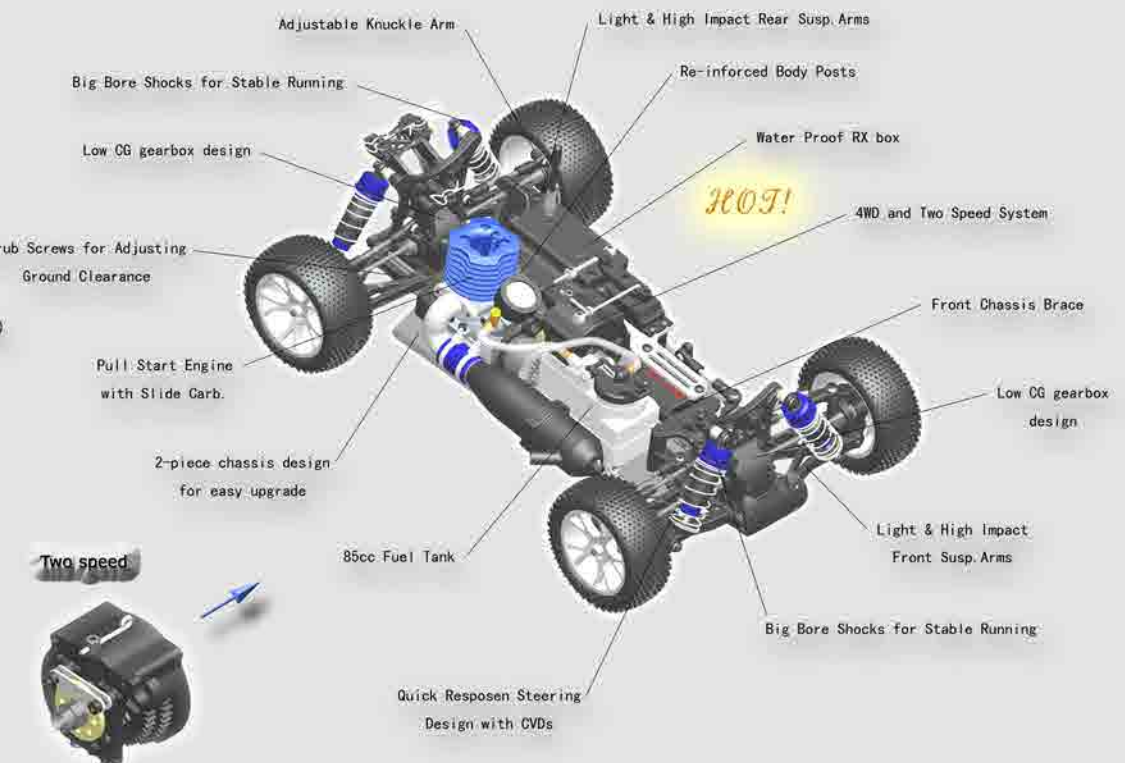

FRONT & REAR SHOCK ASSEMBLY

Front Shocks

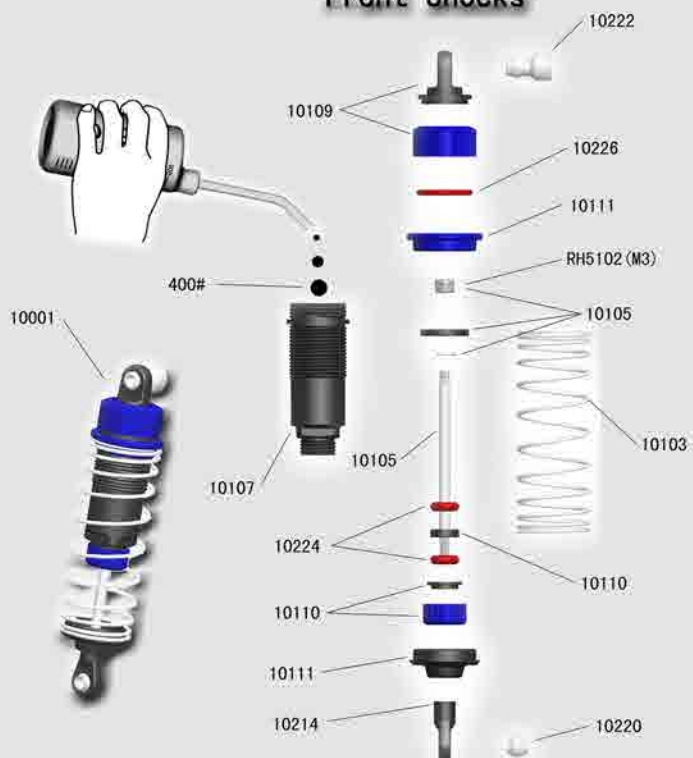

(Dia. 3-1)

Rear Shocks

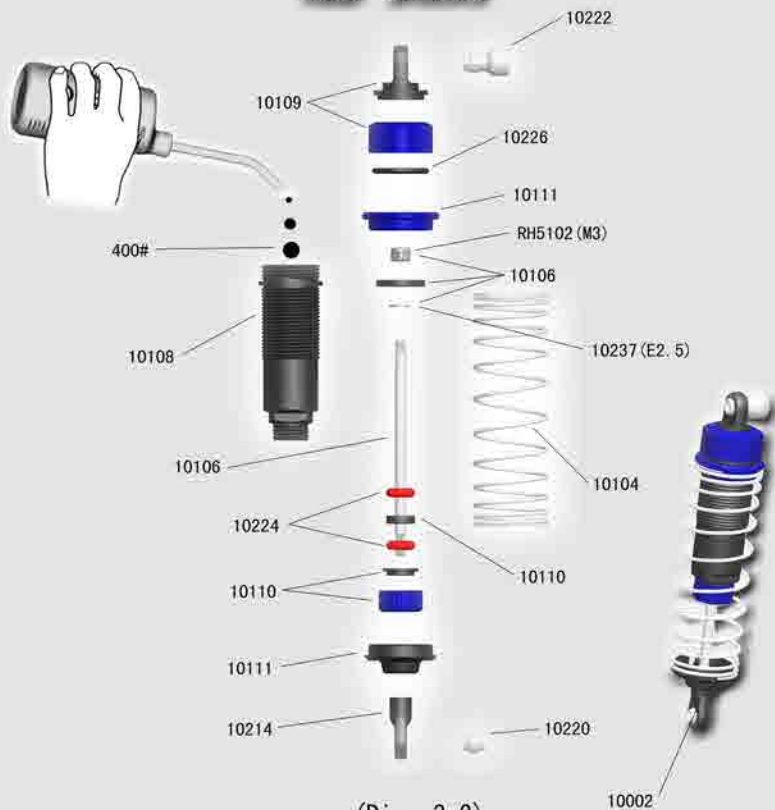

(Dia. 3-2)

Chassis Assembly

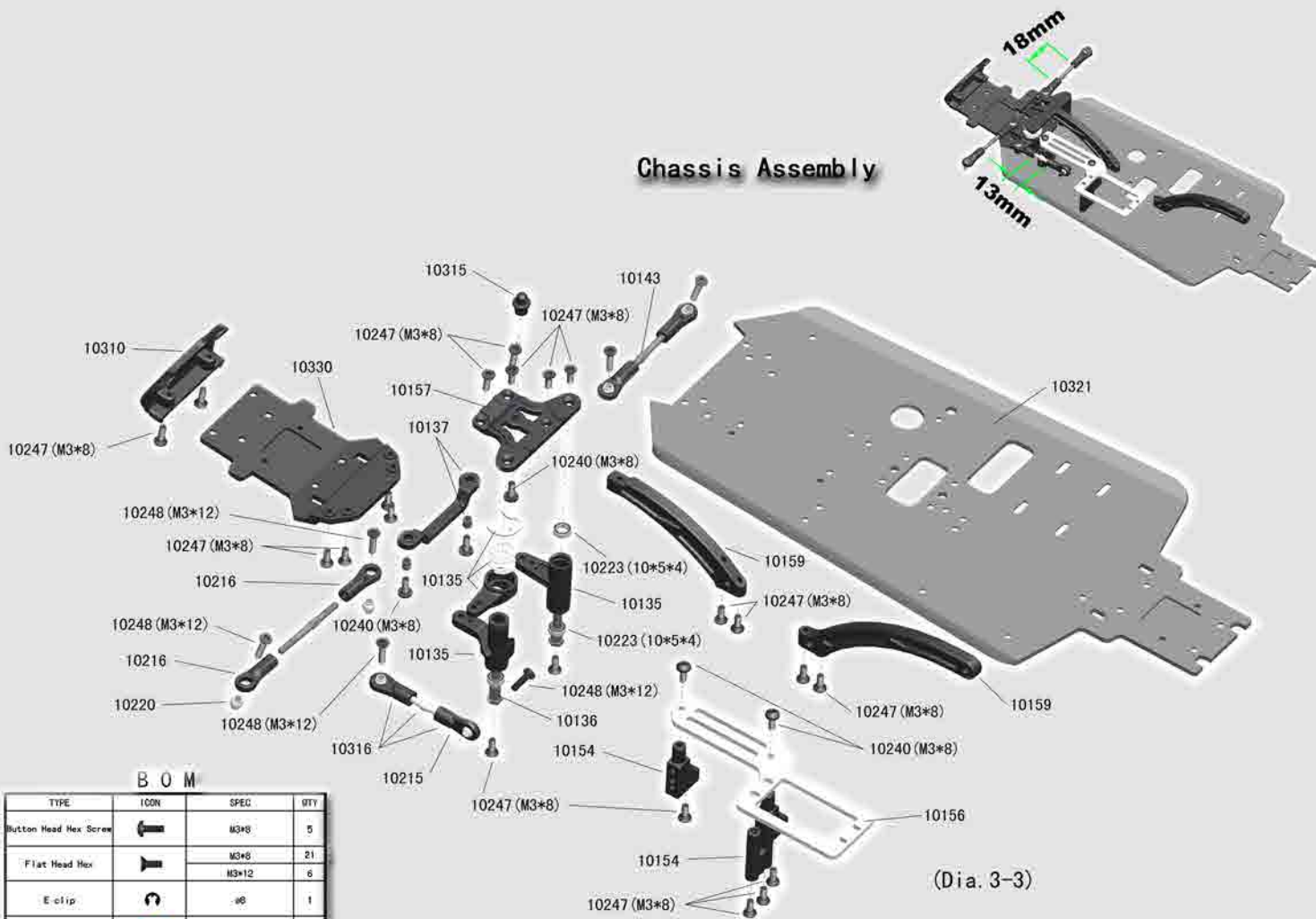

(Dia. 3-3)

B O M

TYPE	ICON	SPEC	QTY
Button Head Hex Screw		M3*8	5
Flat Head Hex		M3*8	21
		M3*12	6
E-clip		#6	1
Ball Bearing		#9x#5x2.5	3

B O M

TYPE	ICDN	SPEC	QTY
Round Head Self Tapping Hex Screw		2x10	4
Button Head Hex Screw		M3x8	4
		M3x10	2
		M3x12	10
		M3x14	3
Flat Head Hex		M3x14	4
		M3x18	2
		M3x35	2
		M3x3	2
Set Screw		M4x4	1
		M4x10	2
Ring Self Tapping Screw		3x4	2
Washer		ø6x3.1x0.2	2
Nylon Lock Nut		M3	2
E clip		ø2.5	5
O' Ring		ø6.05xø4.05xø1.55	4
		ø6.3xø2.5	4
		ø15.6xø12.6xø1.5	2
Ball Bearing		ø15xø10x4	2
		ø10xø5x4	6

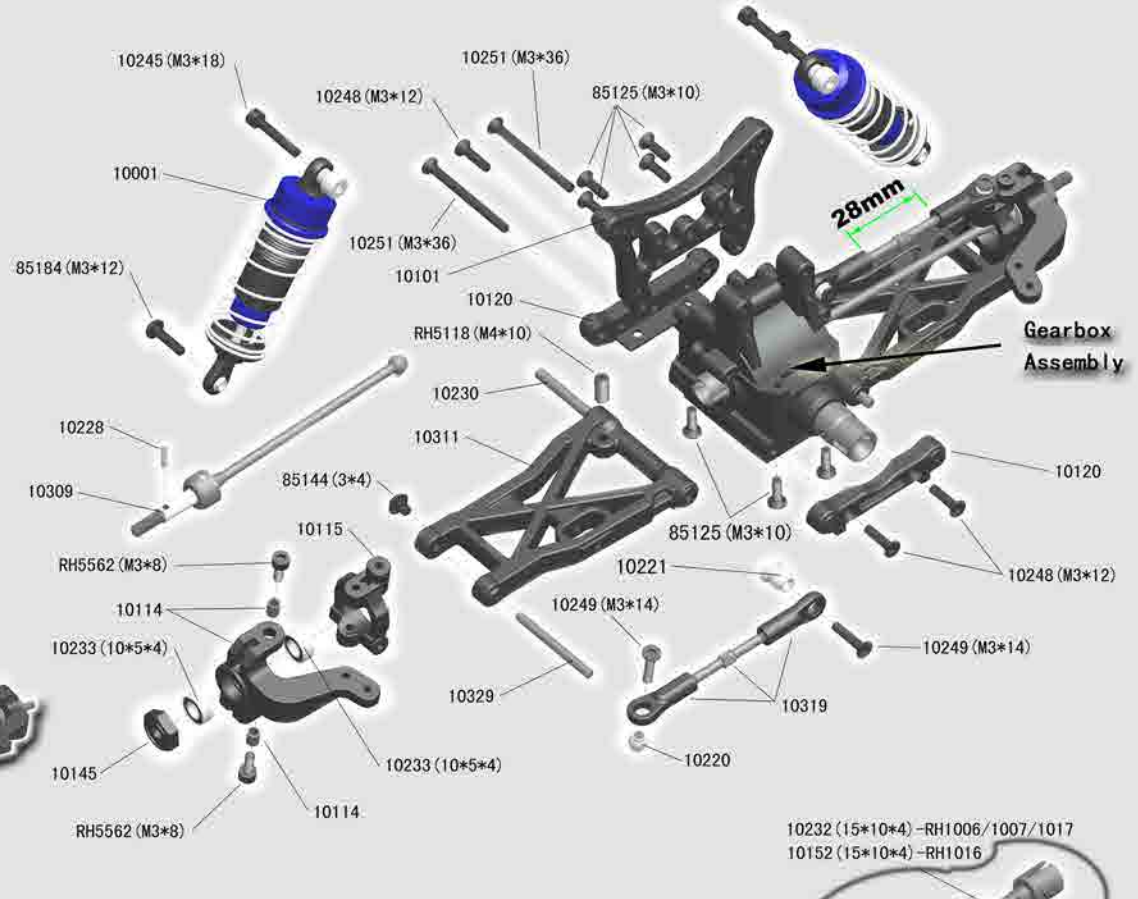

Front Assembly



(Dia. 4-1)

Gearbox Assembly



(Dia. 4-2)

Diff. Box

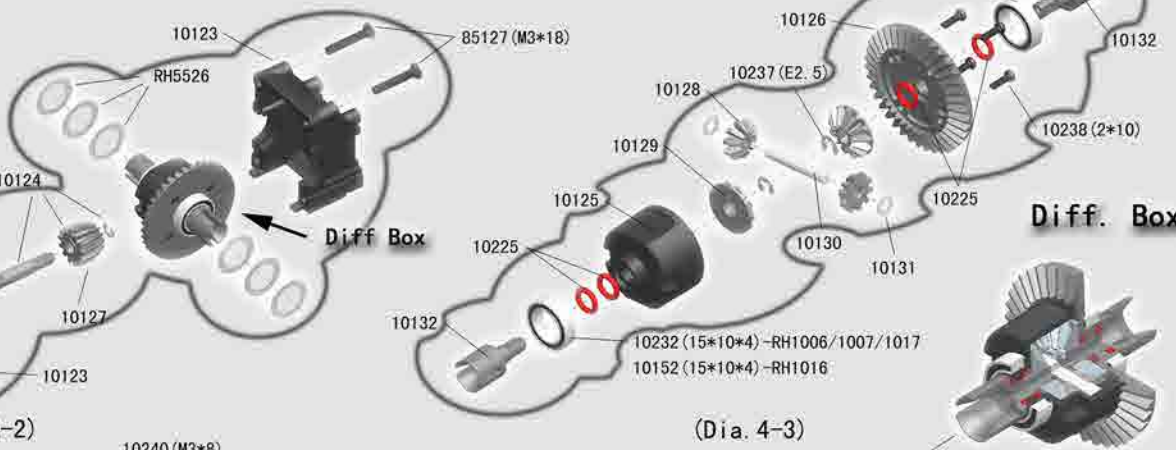

(Dia. 4-3)

Rear Assmely

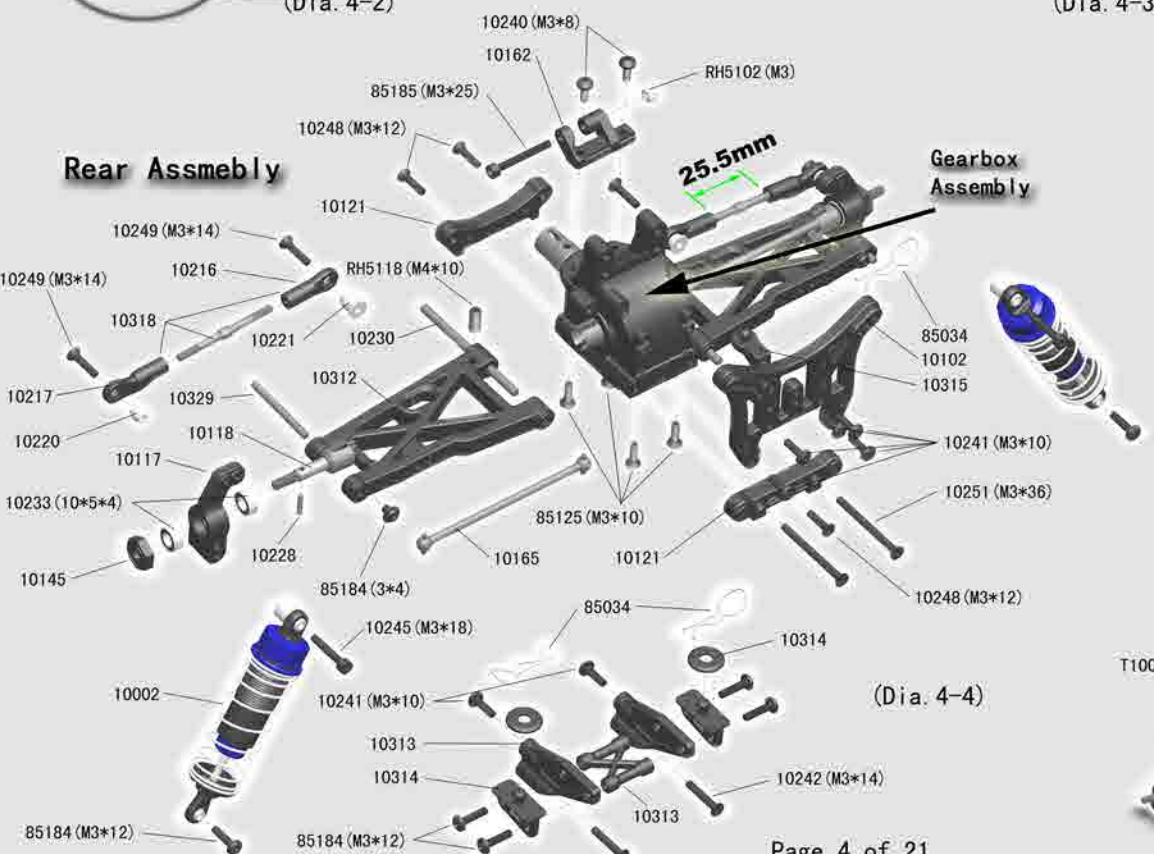

(Dia. 4-4)



B O M

TYPE	ICDN	SPEC	QTY
Round Head Self Tapping Hex Screw		2x10	4
Button Head Hex Screw		M3x8	2
		M3x10	7
		M3x18	6
		M3x25	1
Cap Head Hex Screw		M3x10	4
		M3x12	3
		M3x18	4
		M3x35	2
Set Screw		M4x4	1
		M4x10	2
Ring Self Tapping Screw		3x4	2
Washer		ø6x3.1x0.2	2
Nylon Lock Nut		M3	3
E clip		ø2.5	5
O' Ring		ø6.05xø4.05xø1.55	4
		ø6.3xø2.5	4
		ø15.6xø12.6xø1.5	2
Ball Bearing		ø15xø10x4	2
		ø10xø5x4	6

B O M

TYPE	ICON	SPEC	QTY
Round Head Self Tapping Hex Screw		2#6	4
Button Head Hex Screw		M3#6	4
Cap Head Hex Screw		M3#15	2
		M3#28	5
Flat Head Hex		M3#10	1
Set Screw		M4#4	1
Washer		#6#3.1#0.2	1
Nylon Lock Nut		M3	5
O'Ring		631# 82	1
Ball Bearing		#10#5#4	2

Engine Assembly

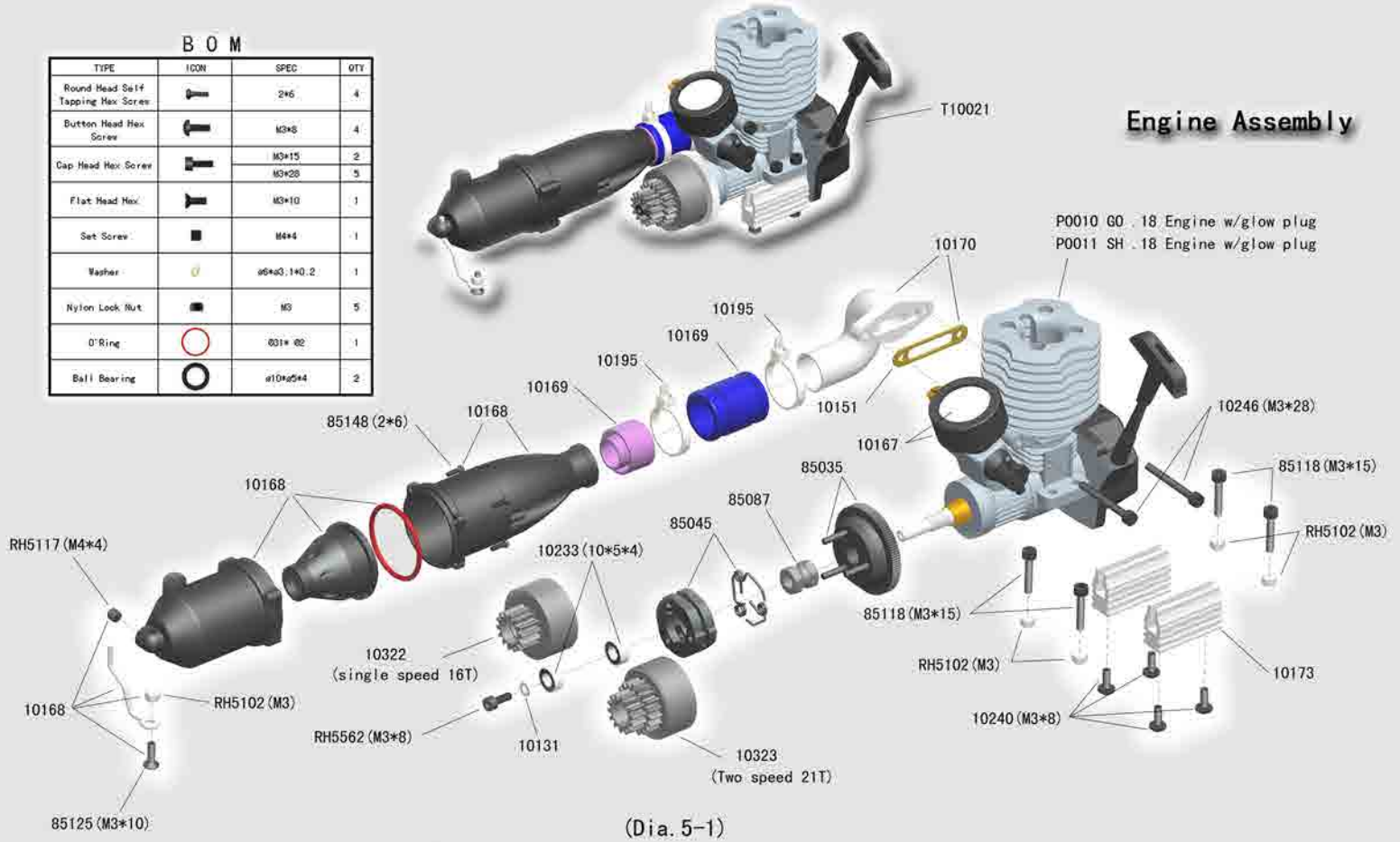

SPIRIT N1 Central Transmission

B O M

TYPE	ICON	SPEC	QTY
Cap Head Hex Screw		M3#10	2
Flat Head Hex		M3#8	4
		M3#20	2
Set Screw		M3#3	1
		M4#4	2
E clip		#4	3
Ball Bearing		#10#5#4	2

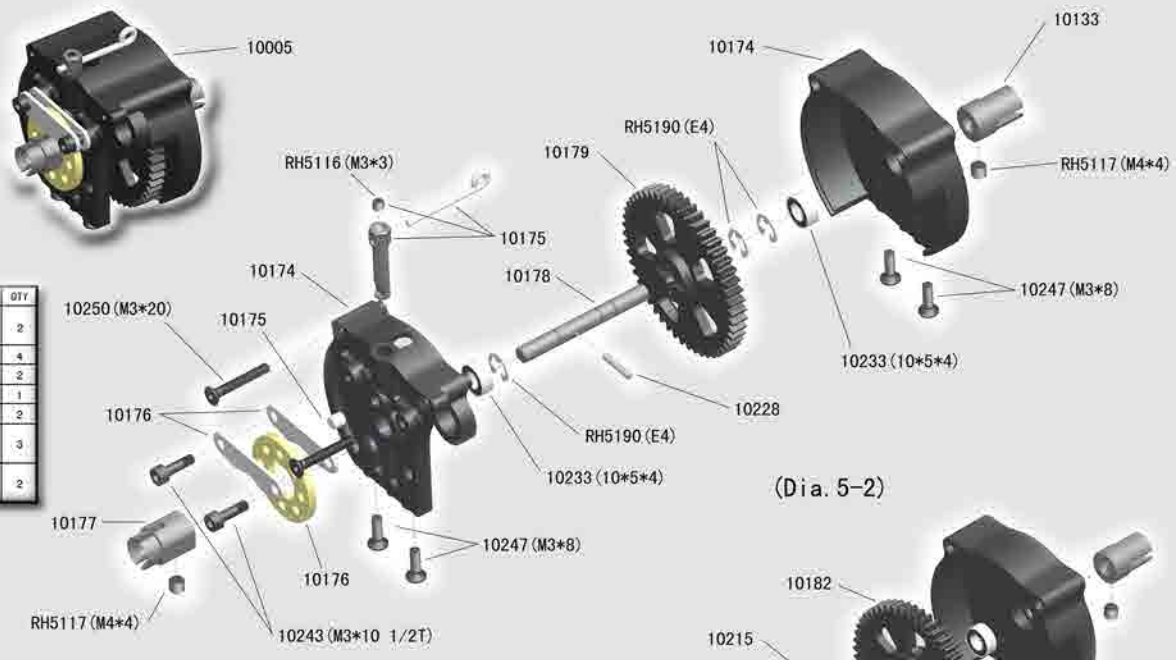

SPIRIT N2 Central Transmission

B O M

TYPE	ICON	SPEC	QTY
Cap Head Hex Screw		M3#10	2
Flat Head Hex		M3#8	4
		M3#20	2
Set Screw		M3#3	1
		M4#4	4
E clip		#4	1
One Way Bearing		#12#6.3#8.4	1
Ball Bearing		#10#5#4	3

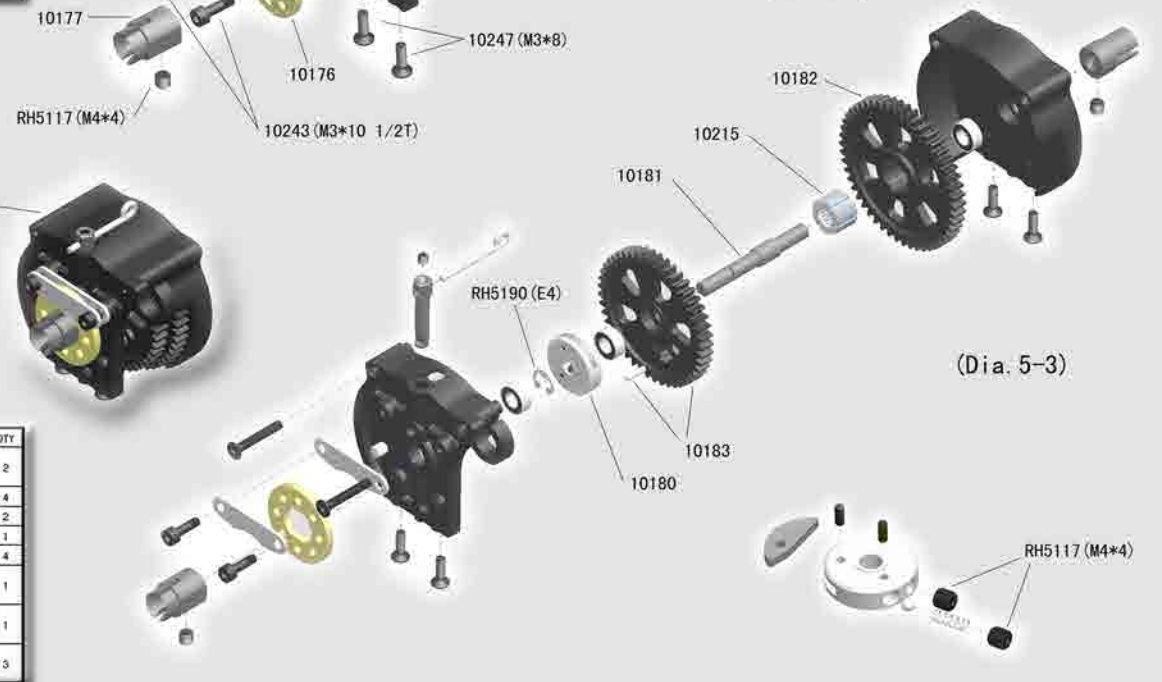

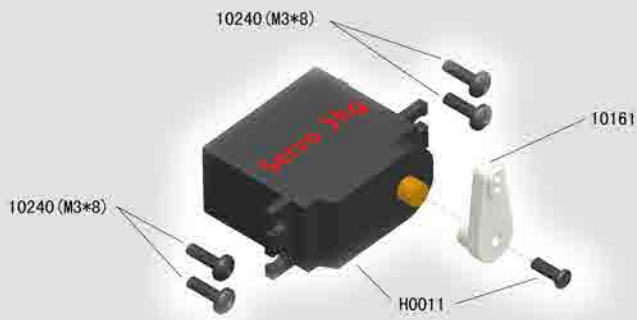

Steering Servo



(Dia. 6-1)

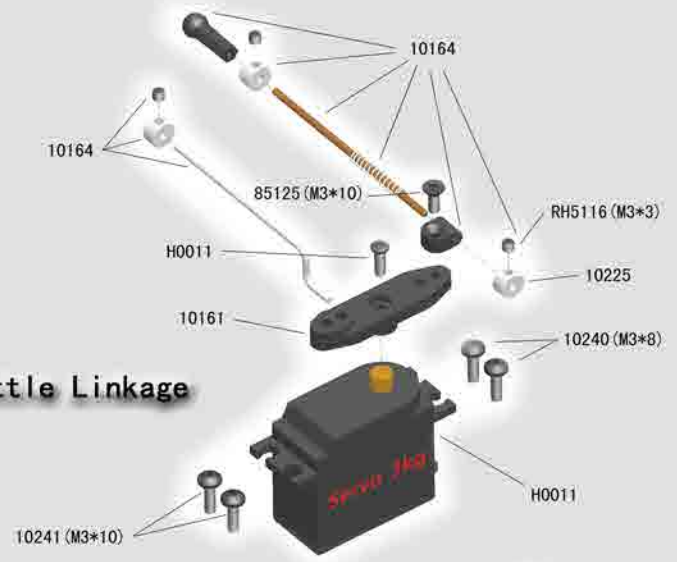

Throttle Linkage



(Dia. 6-2)

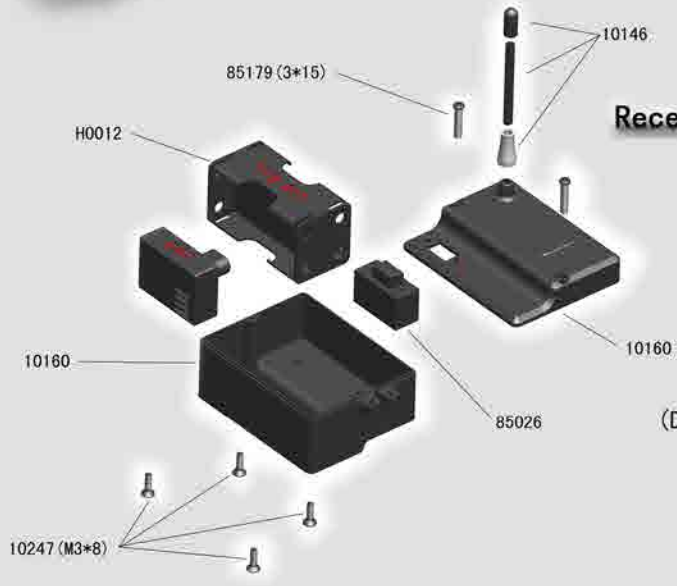

Receiver Assembly



(Dia. 6-3)

Fuel Tank



(Dia. 6-6)

Front Tyres

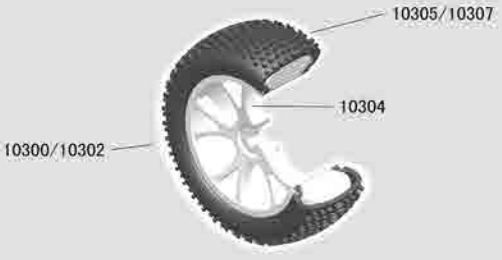

(Dia. 6-4)

Rear Tyres

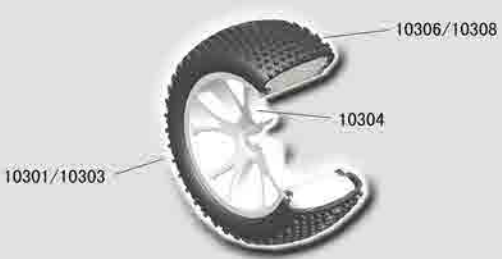

(Dia. 6-5)

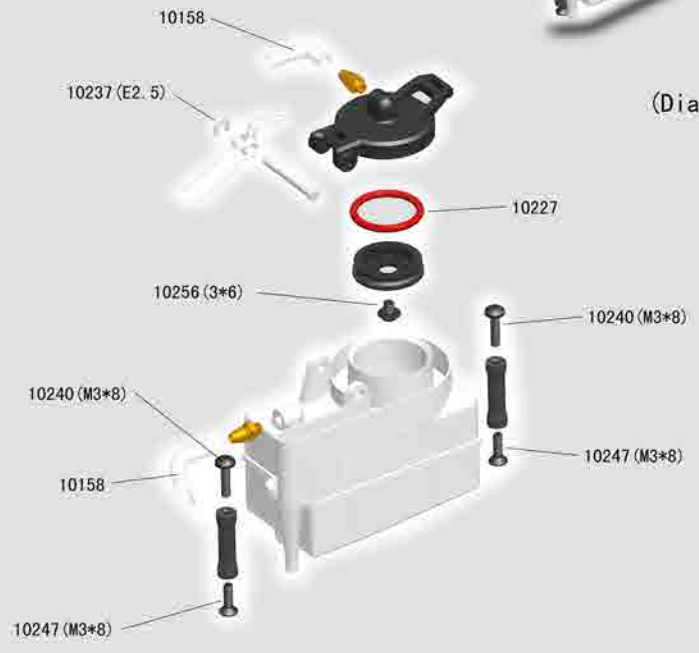

Spirit N1 and N2 are almost in structure but the central transmission (Diagram 5-2 and 5-3).
 For hobbyists, we have optional front and rear sway bar for upgrade, which adds higher racing performance.
 Optional Front & Rear Sway Bar #10325.

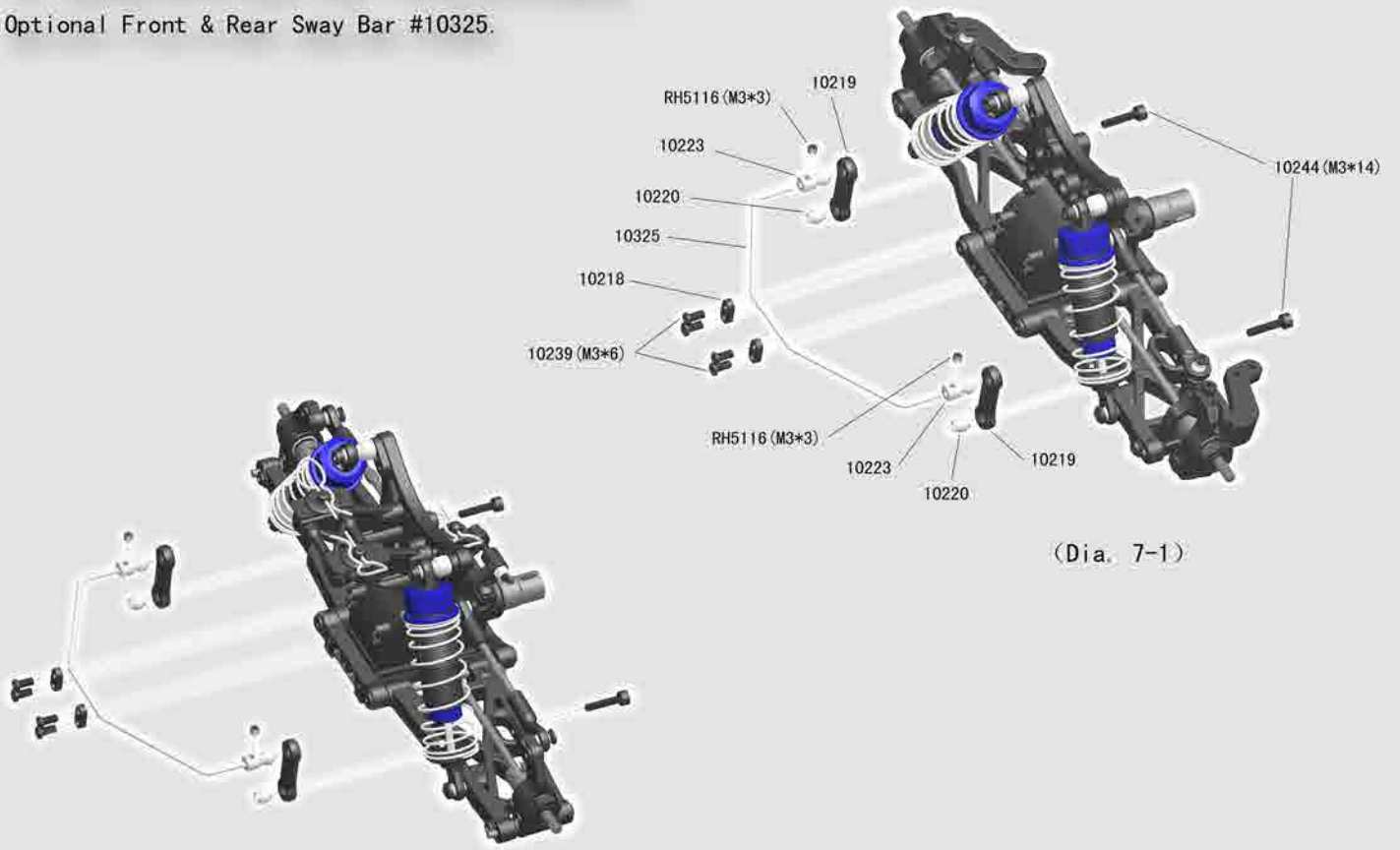

(Dia. 7-1)

(Dia. 7-2)

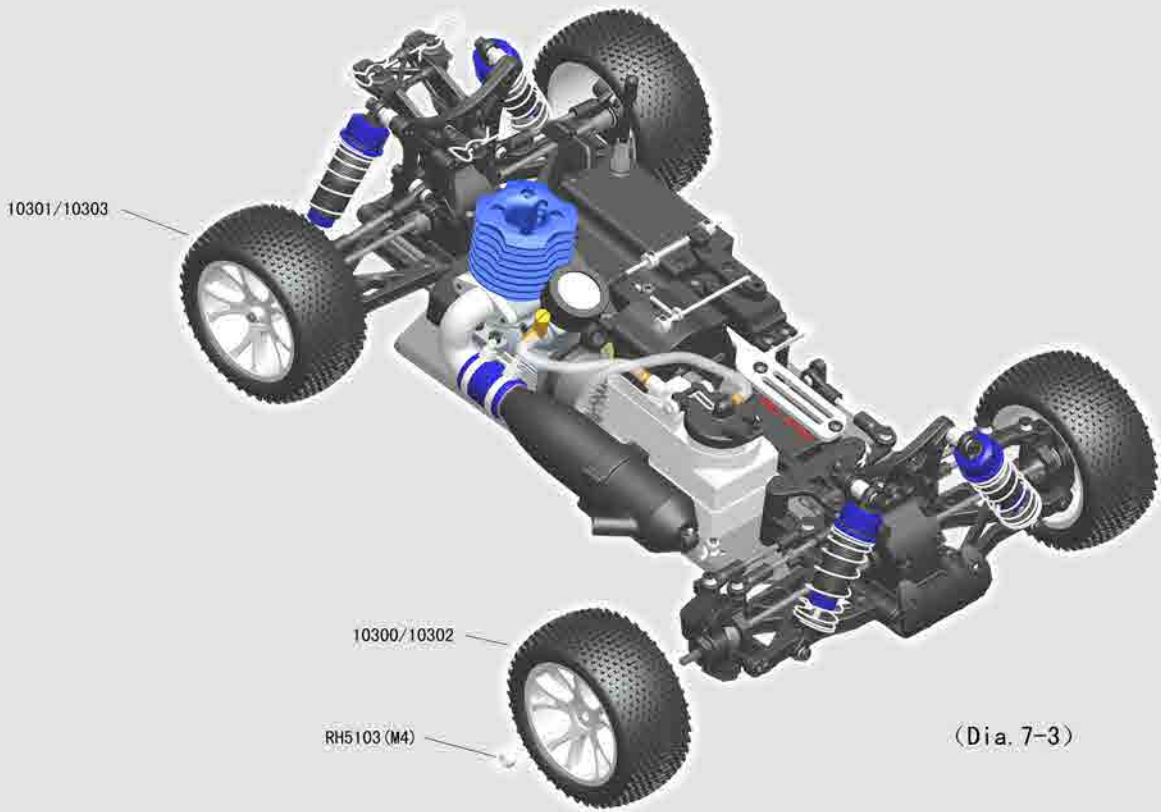

(Dia. 7-3)

Assembly Steps:

1. Fasten the fuel tank posts to the chassis, then the fuel tank assembly. (See Dia. 6-6)

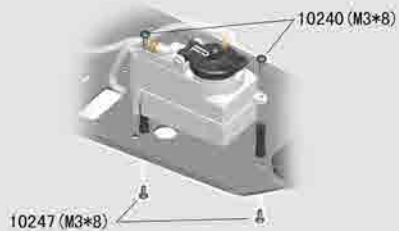

5. Tighten the wheels. (See Dia. 6-4 or 6-5)

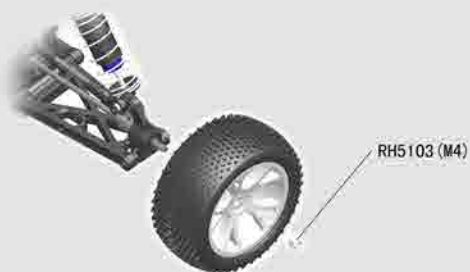

2. Assemble Chassis. (See Dia. 3-3)



6. Assemble central transmission and rear central drive shaft to the chassis. (See Dia. 5-2 or 5-3)

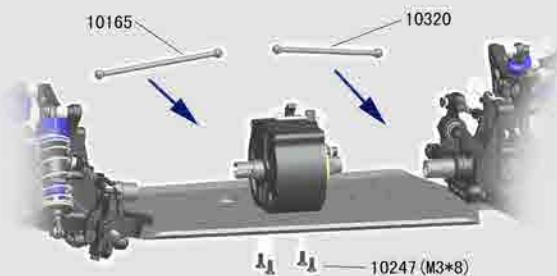

3. Assemble the front assembly to the chassis. (See Dia. 4-1)



4. Assemble the rear assembly to the chassis. (See Dia. 4-4)



7. Tighten the engine assembly to the chassis. (See Dia. 5-1)

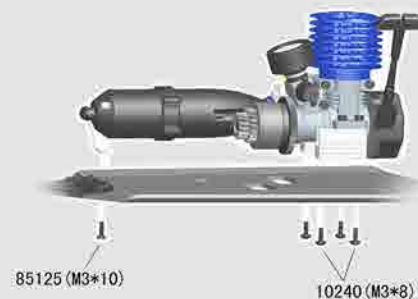

8. Finally assemble the receiver box assembly, throttle/steering servos assembly to the chassis. Setup the radio system and then assemble the cutted body to the body posts. (See Dia. 6-1, 6-2, 6-3)

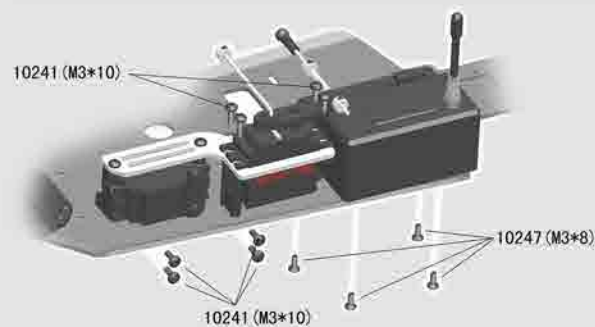

85034

RH1016 SPIRIT EBD (Brushed)

RH1017 SPIRIT EBL (Brushless)

Specs. :

- 1、Length: 415 mm
- 2、Width: 255 mm
- 3、Height: 142 mm
- 4、Wheelbase: 275/280 mm
- 5、Gear Ratio: 8.3:1
- 6、Tyre: $\phi 88 \times 34$ mm (FRONT)
 $\phi 88 \times 39$ mm (REAR)
- 7、Weight: 1710g (SPIRIT EBD)
1650g (SPIRIT EBL)

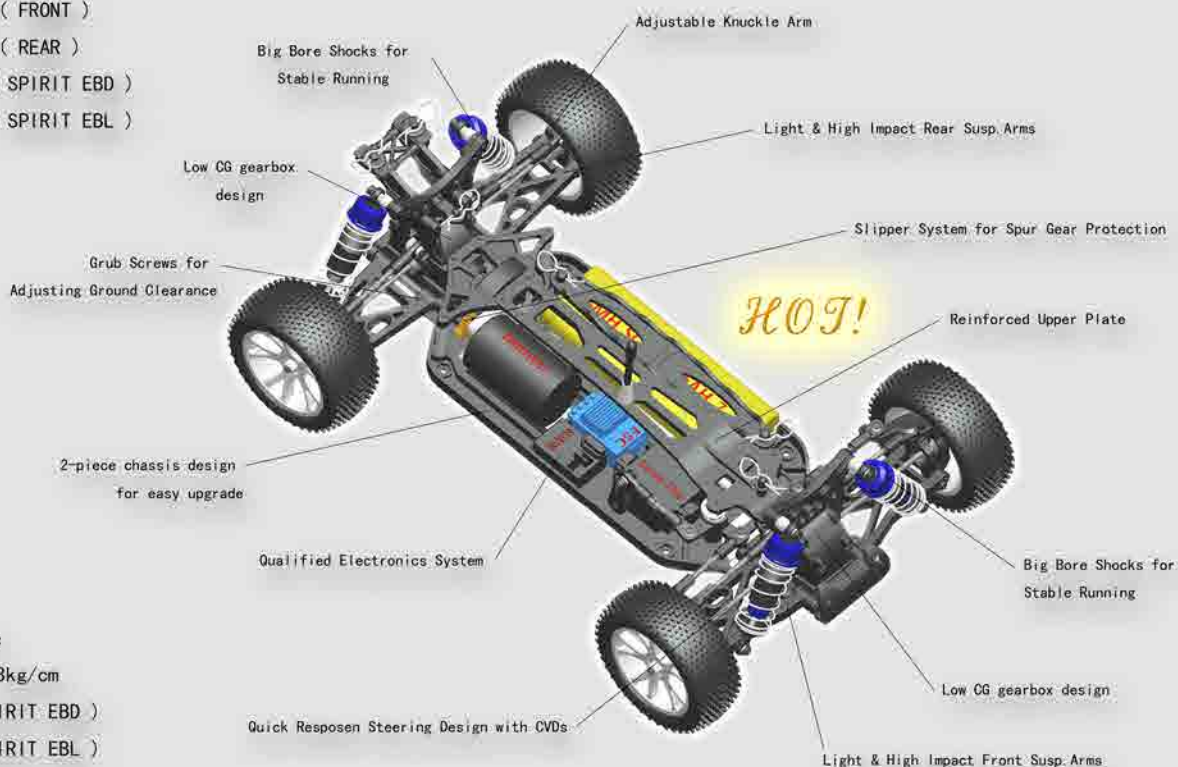

Standard Equipments:

- 1、Steering Servo: 3kg/cm
- 2、Motor: 550 (SPIRIT EBD)
3650 (SPIRIT EBL)
- 3、ESC: 300A (SPIRIT EBD)
60A (SPIRIT EBL)
- 4、Battery: Ni-MH SC1800mAh 7.2V (SPIRIT EBD)
Li-Po 2700mAh 7.4V $\leq 25C$ (SPIRIT EBL)
- 5、RADIO: 2CH A M (SPIRIT EBD)
2CH 2.4GHz (SPIRIT EBL)

SPIRIT EBL Brushless System Set

SPIRIT EBD Brushed System Set



SPIRIT EBD and SPIRIT EBL are converted from SPIRIT N1, having same front assembly. Please refer to Dia. 4-1. And the rear assmbly is all same as SPIRIT N1 but without center outdrive cup(see Dia. 10-2)

Attention: SPIRIT EBD and SPIRIT EBL are only different in ESC, motor battery, charger and radio.

Central Assembly

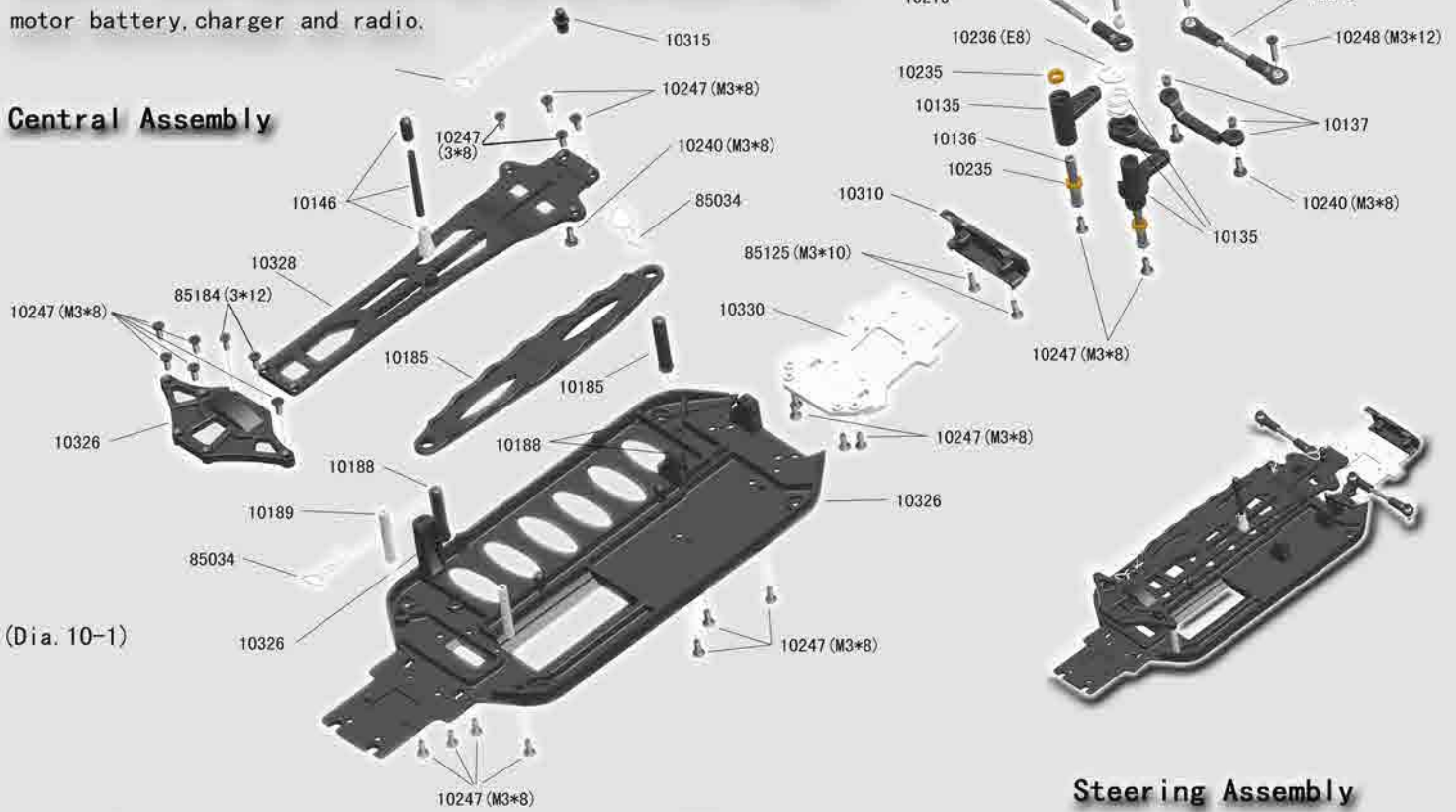

(Dia. 10-1)

Rear Assembly

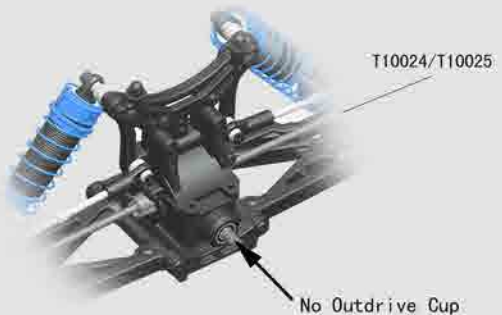

(Dia. 10-2)

ESC



(Dia. 10-3)

Steering Assembly



(Dia. 10-4)

Motor Assembly

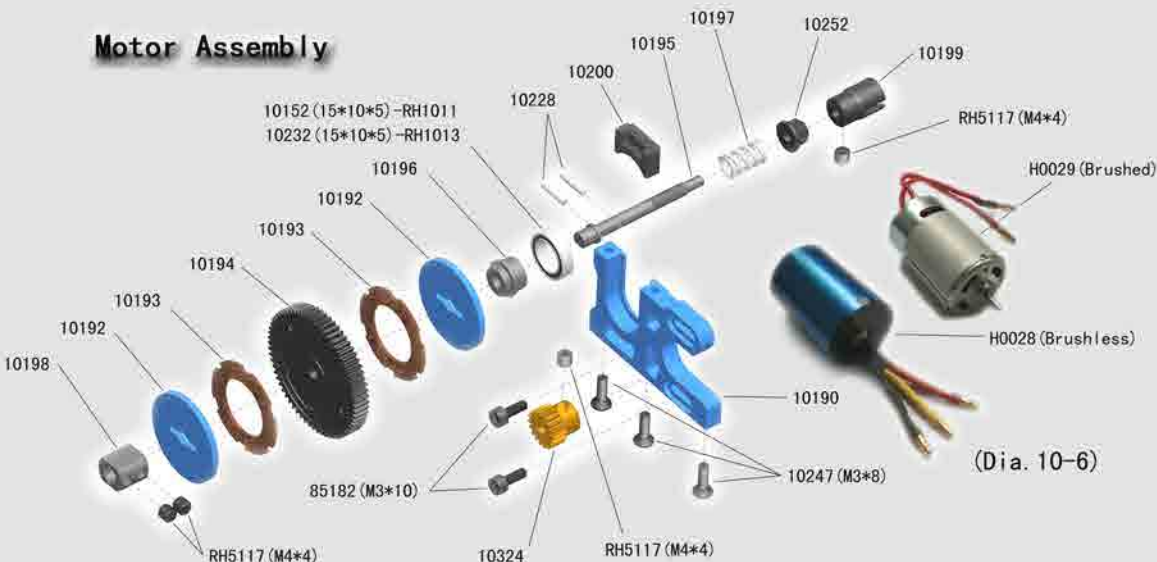

(Dia. 10-6)

Receiver



(Dia. 10-5)



Spirit EBD and EBL is almost same but in electronics. Spirit EBD comes with brushed system and Spirit EBL with brushless system. For hobbyists, we have optional front and rear sway bar for upgrade, which adds higher racing performance.

Other assemblies please refer to Page 10 and Spirit N1 instructions, Optional Front & Rear Sway Bar #10325.

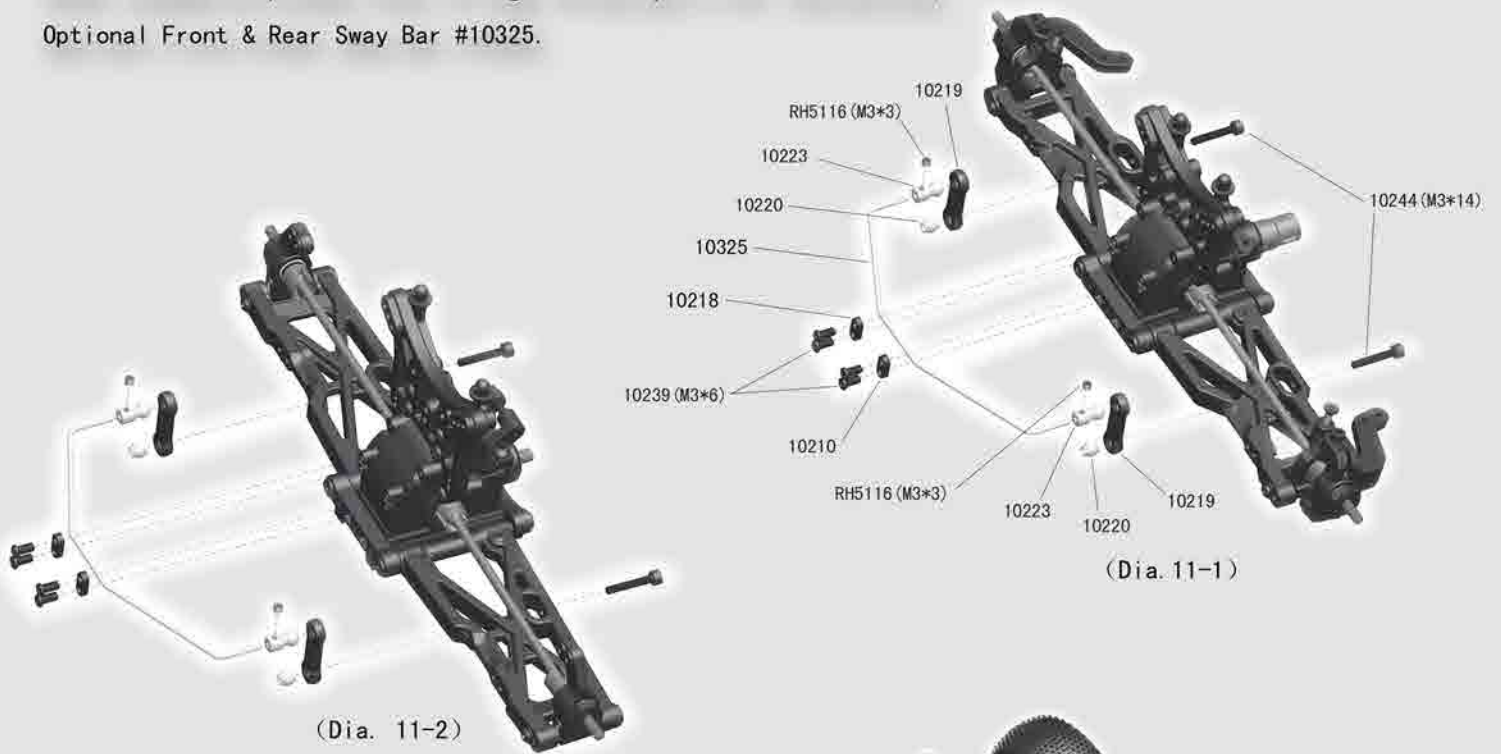

Wheelie Pack:

In order to increase the stability operation under top speed for "Super Player", who plays the car with 3S lipo and running cock-up, we design a wheelie system for option, Optional Front & Rear Sway Bar #10922.

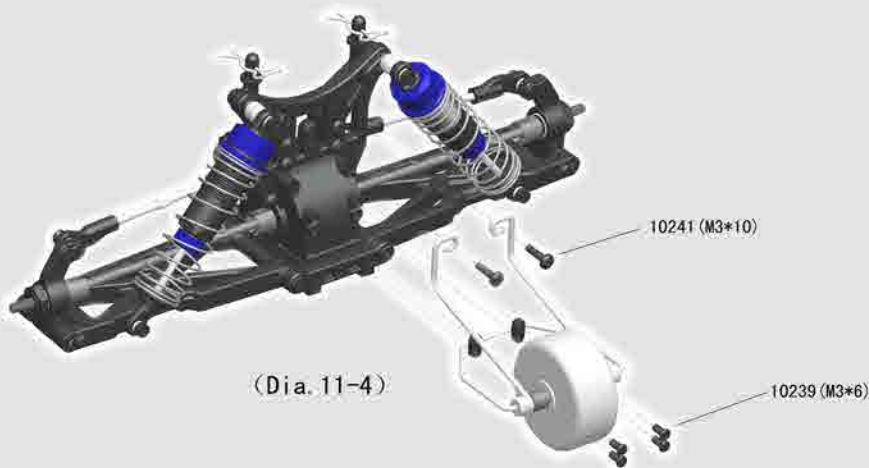
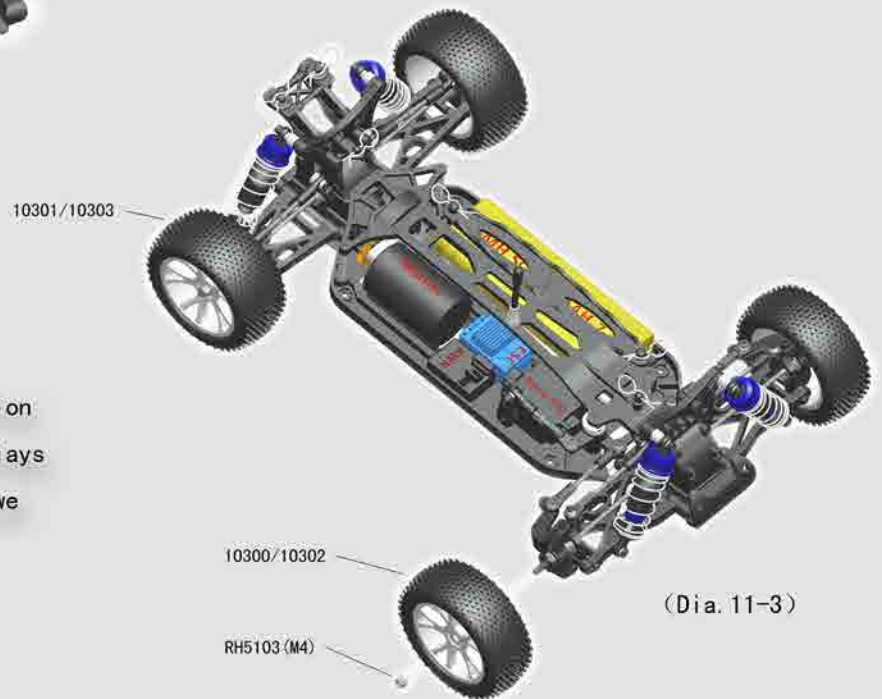

ASSEMBLY STEPS:

1. Assembly center chassis part (See Dia. 10-1)

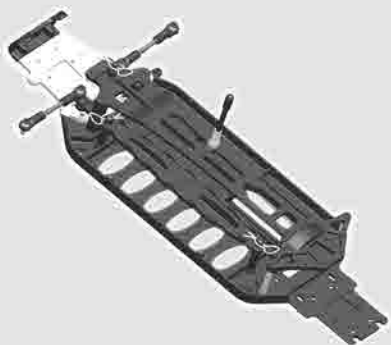

2. Assemble front assembly to chassis front. (See Dia. 4-1)

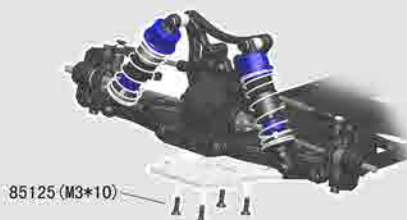

3. Assemble rear assembly to chassis rear part. (See Dia. 4-4)

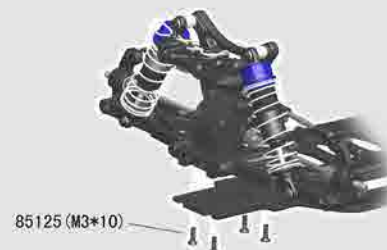

5. Mount the wheels.
(See Dia. 6-4, 6-5)



6. Mount the motor assembly and central drive shaft. (See Dia. 10-6)

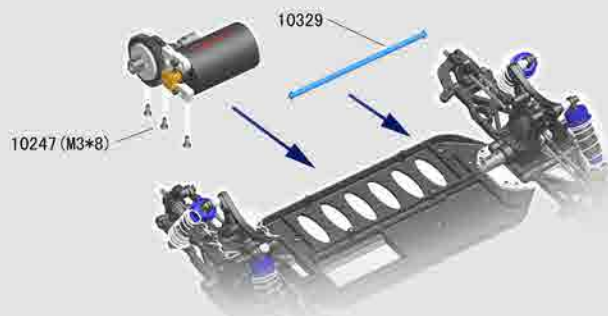

7. Assemble steering servo and linkage. (See Dia. 10-4)

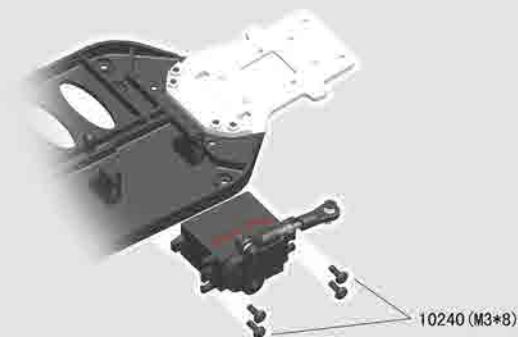

8. Assemble ESC, receiver, battery and connect them to setup. (See Dia. 10-3, 10-5)

Brushless System:



Brushed system:



R0069/R0072/R0073















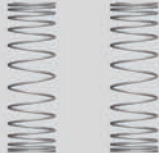









R0075/R0076/R0077



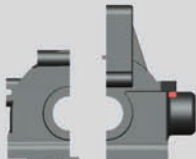







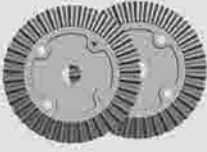















85034











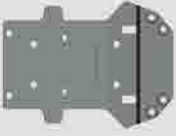

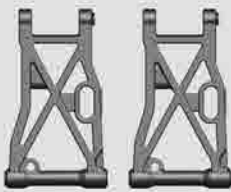
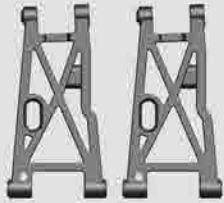











Common Part List

<p>10101 - Front Shock Tower 1pc</p>  <p>RH1006/RH1007/RH1016/RH1017</p>	<p>10102 -Rear Shock Tower 1pc</p>  <p>RH1006/RH1007/RH1016/RH1017</p>	<p>10001-Front Shocks 2pc (Alum Caps) 10019-Front Shocks 2pc (Nylon Caps)</p>  <p>RH1006/RH1007/RH1016/RH1017</p>	<p>10002-Rear shock tower 2pc(Alum caps) 10020-Rear shock tower 2pc(Nylon caps)</p>  <p>RH1006/RH1007/RH1016/RH1017</p>
<p>10103-Front Shock Spring 2pc</p>  <p>RH1006/RH1007/RH1016/RH1017</p>	<p>10104-Rear Shock Spring 2pc</p>  <p>RH1006/RH1007/RH1016/RH1017</p>	<p>10105-Front Shock Shaft & Piston Set 2sets</p>  <p>RH1006/RH1007/RH1016/RH1017</p>	<p>10106-Rear Shock Shaft & Piston Set 2sets</p>  <p>RH1006/RH1007/RH1016/RH1017</p>
<p>10107-Front Shock Body 2pc</p>  <p>RH1006/RH1007/RH1016/RH1017</p>	<p>10108-Rear Shock body 2pc</p>  <p>RH1006/RH1007/RH1016/RH1017</p>	<p>10109-Shock Upper Cap 2sets</p>  <p>RH1006/RH1007/RH1016/RH1017</p>	<p>10110-Shock Lower Caps 2sets</p>  <p>RH1006/RH1007/RH1016/RH1017</p>
<p>10111-Shock Lower holder & Adjust Ring 2sets</p>  <p>RH1006/RH1007/RH1016/RH1017</p>	<p>10114-Steering Knuckle Arm 1set</p>  <p>RH1006/RH1007/RH1016/RH1017</p>	<p>10115-Uprights 2pc</p>  <p>RH1006/RH1007/RH1016/RH1017</p>	<p>10117-Rear Hub Carrier 2pc</p>  <p>RH1006/RH1007/RH1016/RH1017</p>
<p>10118-Rear Drive Shaft 2pc</p>  <p>RH1006/RH1007/RH1016/RH1017</p>	<p>10120-Front Susp. Holders 2pc</p>  <p>RH1006/RH1007/RH1016/RH1017</p>	<p>10121-Rear Susp. Holders 2pc</p>  <p>RH1006/RH1007/RH1016/RH1017</p>	<p>10123-Gearbox Housing Set 2pcs</p>  <p>RH1006/RH1007/RH1016/RH1017</p>
<p>RH5526-Diff 16T Gear Washer 6pcs</p>  <p>RH1006/RH1007/RH1016/RH1017</p>	<p>10124-Diff. Drive Gear w/pin 2sets</p>  <p>RH1006/RH1007/RH1016/RH1017</p>	<p>10003-Diff Gearbox Set 1set</p>  <p>RH1006/RH1007/RH1016/RH1017</p>	<p>10125-Diff Case 2pcs</p>  <p>RH1006/RH1007/RH1016/RH1017</p>

Common Part List

<p>10126-Diff Drive Spur Gear 2pcs</p>  <p>38T</p> <p>RH1006/RH1007/RH1016/RH1017</p>	<p>10127-Diff Drive Gear 2pcs</p>  <p>13T</p> <p>RH1006/RH1007/RH1016/RH1017</p>	<p>10128-Diff Bevel Gear S. 4pcs</p>  <p>10T</p> <p>RH1006/RH1007/RH1016/RH1017</p>	<p>10129-Diff Bevel Gear B. 4pcs</p>  <p>13T</p> <p>RH1006/RH1007/RH1016/RH1017</p>
<p>10130-Diff Pin 2pcs</p>  <p>RH1006/RH1007/RH1016/RH1017</p>	<p>10131-Washer 6pcs</p>  <p>RH1006/RH1007/RH1016/RH1017</p>	<p>10132-Diff Drive Cup 4pcs</p>  <p>RH1006/RH1007/RH1016/RH1017</p>	<p>10133-Center Coupler 3pcs</p>  <p>RH1006/RH1007/RH1016/RH1017</p>
<p>10135-Servo Saver (GP) 1set</p>  <p>RH1006/RH1007</p>	<p>10136-Servo Saver Post 2pcs</p>  <p>RH1006/RH1007/RH1016/RH1017</p>	<p>10137-Steering Ackerman</p>  <p>RH1006/RH1007/RH1016/RH1017</p>	<p>10145-Wheel Hub 4pcs</p>  <p>RH1006/RH1007/RH1016/RH1017</p>
<p>10146-Antenna Pipe Set 2sets</p>  <p>RH1006/RH1007/RH1016/RH1017</p>	<p>10147-Servo Saver (EP) 1set</p>  <p>RH1016/RH1017</p>	<p>10300-Front buggy tyre set 2sets</p>  <p>RH1006/RH1007/RH1016/RH1017</p>	<p>10301-Rear buggy tyre set 2sets</p>  <p>RH1006/RH1007/RH1016/RH1017</p>
<p>10302-Front buggy tyre set 2sets</p>  <p>RH1006/RH1007/RH1016/RH1017</p>	<p>10303-Rear buggy tyre set 2sets</p>  <p>RH1006/RH1007/RH1016/RH1017</p>	<p>10304-Front Rim 2pcs 10332-Rear Rim 2pcs</p>  <p>RH1006/RH1007/RH1016/RH1017</p>	<p>10305-Front tyres & inner foams 2sets</p>  <p>RH1006/RH1007/RH1016/RH1017</p>
<p>10306-Rear tyres & inner foams 2sets</p>  <p>RH1006/RH1007/RH1016/RH1017</p>	<p>10307-Front tyres & inner foams 2sets</p>  <p>RH1006/RH1007/RH1016/RH1017</p>	<p>10308-Rear tyres & inner foams 2sets</p>  <p>RH1006/RH1007/RH1016/RH1017</p>	<p>10309-Front CVD 2sets</p>  <p>RH1006/RH1007/RH1016/RH1017</p>















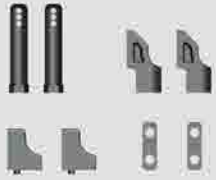





Part List

<p>10330-Chassis Front Part 1pc</p>  <p>RH1006/RH1007/RH1016/RH1017</p>	<p>10310-Front Bumper buggy 1pc</p>  <p>RH1006/RH1007/RH1016/RH1017</p>	<p>10311-Front Lower Susp. Arm 2pc</p>  <p>RH1006/RH1007/RH1016/RH1017</p>	<p>10312-Rear Lower Susp. Arm 2pc</p>  <p>RH1006/RH1007/RH1016/RH1017</p>
<p>10313-Wing Bracket 1set</p>  <p>RH1006/RH1007/RH1016/RH1017</p>	<p>10314-Wing Holder 1set</p>  <p>RH1006/RH1007/RH1016/RH1017</p>	<p>10315-Buggy Body Mount 1set</p>  <p>RH1006/RH1007/RH1016/RH1017</p>	<p>10316-Servo Linkage 1pc</p>  <p>10317-Front Upper Susp. Arm 2sets.</p>  <p>RH1006/RH1007/RH1016/RH1017</p>
<p>10318-Rear Upper Susp. Arm 2sets</p>  <p>RH1006/RH1007/RH1016/RH1017</p>	<p>10319-Steering Arm 2sets</p>  <p>RH1006/RH1007/RH1016/RH1017</p>	<p>10320-Central Dongbone R. 1pc</p>  <p>RH1006/RH1007/RH1016/RH1017</p>	<p>10321-Chassis Plate Rear Part 1pc</p>  <p>RH1006/RH1007</p>
<p>10151-Manifold Gasket 6pc</p>  <p>RH1006/RH1007</p>	<p>10152-Metal Bushing 15*10*4 6pc</p> 	<p>10153-Metal Bushing 8*5*2.5 6pc</p> 	<p>10154-Servo & Upper Plate Mounts 1set</p>  <p>RH1006/RH1007</p>
<p>10156-Upper Plate 1pc</p>  <p>RH1006/RH1007</p>	<p>10157-Upper Steering Plate</p>  <p>RH1006/RH1007</p>	<p>10004-Fuel tank Set 1set</p>  <p>RH1006/RH1007</p>	<p>10158-Fuel Line 2pcs.</p>  <p>RH1006/RH1007</p>
<p>10159-Front/Rear Chassis Brace</p>  <p>RH1006/RH1007</p>	<p>10160-Receiver Box 1set</p>  <p>RH1006/RH1007</p>	<p>85026-Switch Cover 2pcs</p>  <p>RH1006/RH1007</p>	<p>10161-Servo Horns</p>  <p>RH1006/RH1007</p>





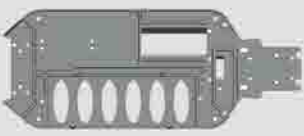

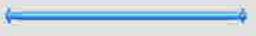













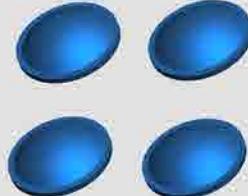
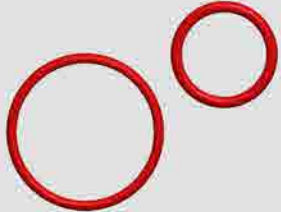

Part List

<p>10162-Chassis Brace mount 1pc</p>  <p>RH1006/RH1007</p>	<p>10163-Stopper 6pcs</p>  <p>RH1006/RH1007</p>	<p>10164-Throttle Linkage 1set</p>  <p>RH1006/RH1007</p>	<p>10165-Central Dongbone F. 1pc</p>  <p>RH1006/RH1007</p>
<p>P0010-GO. 18 engine 1pc P0011-SH. 18 Engine 1pc</p>  <p>RH1006/RH1007</p>	<p>10167-Air filter 1Set</p>  <p>RH1006/RH1007</p>	<p>10168-Tuned Pipe 1Set</p>  <p>RH1006/RH1007</p>	<p>10169-Silicone Coupler 1Set</p>  <p>RH1006/RH1007</p>
<p>85195-Zip Tie 6pcs</p>  <p>RH1001/RH1002/RH1011/RH1013</p>	<p>10170-Manifold 1Set</p>  <p>RH1006/RH1007</p>	<p>85035-Flywheel 1pc</p>  <p>RH1006/RH1007</p>	<p>85087-Clutch Nut 2pcs</p>  <p>RH1006/RH1007</p>
<p>85045-Clutch Shoes & Springs</p>  <p>RH1006/RH1007</p>	<p>10173-Engine mount 2pcs</p>  <p>RH1006/RH1007</p>	<p>10331-Clutch Bell (16T) 1pc</p>  <p>RH1006</p>	<p>10322-Clutch Bell (21T) 1pc</p>  <p>RH1007</p>
<p>10005-Central Transmission Complete 1Set (Single Speed)</p>  <p>RH1006</p>	<p>10174-Central Transmission Bulkheads 2pcs</p>  <p>RH1006/RH1007</p>	<p>10175-Brake Post 1Set</p>  <p>RH1006/RH1007</p>	<p>10176-Brake Set 1set</p>  <p>RH1006/RH1007</p>
<p>10177-Brake Cup 2pcs</p>  <p>RH1006/RH1007</p>	<p>10178-Single Speed Shaft w/pin</p>  <p>RH1006</p>	<p>10179-50T Gear (Single Speed) 1pc</p>  <p>RH1006</p>	<p>10006-Central Transmission Complete 1Set (Two Speed)</p>  <p>RH1007</p>

























Part List

<p>10180-Two Speed Clutch 1Set</p>  <p>RH1007</p>	<p>10181-Two Speed Shaft 1pc</p>  <p>RH1007</p>	<p>10182-50T Two Speed Gear 1pc</p>  <p>RH1007</p>	<p>10183-45T Two Speed Gear 1pc</p>  <p>RH1007</p>
<p>10185-Battery Cover (EP) 1pc</p>  <p>RH1016/RH1017</p>	<p>10188-Battery Post 2sets</p>  <p>RH1016/RH1017</p>	<p>10189-Post for Rear Spur Gear Cover 2pc</p>  <p>RH1016/RH1017</p>	<p>10190-Motor Mount (EP) 1pc</p>  <p>RH1016/RH1017</p>
<p>10191-Slipper Complete (EP) 1set</p>  <p>RH1016/RH1017</p>	<p>10192-Slipper Pad (EP) 2pc</p>  <p>RH1016/RH1017</p>	<p>10193-Slipper Gasket (EP) 2pc</p>  <p>RH1016/RH1017</p>	<p>10194-65T Spur Gear (EP) 1pc</p>  <p>RH1016/RH1017</p>
<p>10195 - Slipper Shaft (EP) 1pc</p>  <p>RH1016/RH1017</p>	<p>10196-Slipper Spring Bracket (EP) 1pc</p>  <p>RH1016/RH1017</p>	<p>10197-Slipper Spring (EP) 1pc</p>  <p>RH1016/RH1017</p>	<p>10198-Slipper Coupler (EP) 1pc</p>  <p>RH1016/RH1017</p>
<p>10199-Slipper Drive Cup 1pc</p>  <p>RH1016/RH1017</p>	<p>10200-BEARING BRACKET (EP) 1pc</p>  <p>RH1016/RH1017</p>	<p>10323-Pinion Gear 23T (EP) 1pc</p>  <p>RH1016/RH1017</p>	<p>10324-Sway Bar 2Sets</p>  <p>RH1006/RH1007/RH1016/RH1017</p>
<p>10325-EP Chassiss plate 1pc</p>  <p>RH1016/RH1017</p>	<p>10326-Rear Spur Gear Cover (EP) 1pc</p>  <p>RH1016/RH1017</p>	<p>10327-Upper plate (EP) 1pc</p>  <p>RH1016/RH1017</p>	<p>10328-Center Drive Shaft (EP) 1pc</p>  <p>RH1016/RH1017</p>

Part List

<p>85034-Body Clip (Medium Size) 6pcs</p> 	<p>85029-Body Clip (Small Size) 6pcs</p> 	<p>10214-Shock Ball End 6pcs</p> 	<p>10215-Servo Link Ball End 6pcs</p> 
<p>10216-Steering Linkage Ball End 6pcs</p> 	<p>10217-Rear Upper Linkage Ball End 6pcs</p> 	<p>10218-Sway Bar Fix Plate 6pcs</p> 	<p>10219-Sway Bar Holders 6pcs</p> 
<p>10220-Ball A 6pcs</p> 	<p>10221-Ball B 6pcs</p> 	<p>10222-Ball C 6pcs</p> 	<p>10223-Ball D 6pcs</p> 
<p>10224-Shock O-ring (Lower) 6pcs</p> 	<p>10225-Diff O-ring Seal 6pcs</p> 	<p>10226-Shock Seal Cover 4pcs</p> 	<p>10227-Tuned Pipe Seal & Fuel Tank Seal 1set</p> 
<p>10228-Pin ϕ2*10 6pcs</p> 	<p>10229-Pin ϕ2*11 6pcs</p> 	<p>10329-Hinge Pins (long & short) 1sets</p> 	<p>10231-One Way Bearing 3pcs</p> 
<p>10232-Ball Bearing 15*10*4 6pcs</p> 	<p>10233-Ball Bearing 10*5*4 6pcs</p> 	<p>10234-Metal Bushing 10*5*4 6pcs</p> 	<p>10235-Ball Bearing 8*5*2.5 6pcs</p> 

Part List

<p>10236-E clip-8mm 4pc</p> 	<p>RH5190-E clip-4mm 6pc</p> 	<p>10237-E clip-2.5mm 6pc</p> 	<p>RH5102-Nylon Lock Nut M3 6pc</p> 
<p>RH5103-Nylon Lock Nut-M4 6pc</p> 	<p>85148-Round Head Self Tapping Hex Screw 2*6 4pcs</p> 	<p>10238-Round Head Self Tapping Hex Screw 2*10 6pc</p> 	<p>85179-Round Head Self Tapping Hex Screw 3*15 8pc</p> 
<p>10239-Round Head Self Tapping Hex Screw M3*6 6pc</p> 	<p>10240-Button Head Hex Screw M3*8 6pc</p> 	<p>10241-Button Head Hex Screw M3*10 6pc</p> 	<p>85184-Button Head Hex Screw M3*12 6pc</p> 
<p>10242-Button Head Hex Screw M3*14 6pc</p> 	<p>85144-Ring Self Tapping Screw 3*4 4pc 10256-Ring Self Tapping Screw 3*6 6pc</p> 	<p>RH5116-Set Screw M3*3 6pc</p> 	<p>RH5117-Set Screw M4*4 6pc</p> 
<p>RH5118-Button Head Hex Screw M4*10 6pc</p> 	<p>RH5562-Cap Head Hex Screw M3*8 6pc</p> 	<p>10243-Cap Head Hex Screw M3*10 6pc</p> 	<p>85182-Cap Head Hex Screw M3*10 6pc</p> 
<p>10244-Cap Head Hex Screw M3*14 6pc</p> 	<p>85118-Cap Head Hex Screw M3*15 6pc</p> 	<p>10245-Cap Head Hex Screw M3*18 6pc</p> 	<p>85185-Cap Head Hex Screw M3*25 6pc</p> 

Part List

<p>10246-Cap Head Hex Screw M3*28 6p</p> 	<p>10247-Flat Head Hex M3*8 6pc</p> 	<p>85125-Flat Head Hex Screw M3*10 8p</p> 	<p>10248-Flat Head Hex Screw M3*12 6p</p> 
<p>10249-Flat Head Hex Screw M3*14 6p</p> 	<p>85127-Flat Head Hex Screw M3*18 3p</p> 	<p>10250-Flat Head Hex Screw M3*20 6p</p> 	<p>10251-Flat Head Hex Screw M3*36 6p</p> 
<p>H0068 2.4G FS-GT2 TX&RX</p> 	<p>H0014 - 2.4GHz Transmitter 1pc</p> 	<p>H0072 ks 45A ESC 1pc</p> 	<p>H0050-400A ESC 1pc</p> 
<p>H0028 - 3650 Brushless Motor 1pc</p> 	<p>H0029 - 550 Brushed Motor 1pc</p> 	<p>H0030 - Ni-MH 7.2V 1800mAh 1pc H0031 - Ni-MH 7.2V 3000mAh 1pc</p> 	<p>H0012 - Battery Case 1pc RH5189 - Receiver Switch 1pc</p> 
<p>H0011 - 3kg/cm Servo 1pc</p> 	<p>R0068- Clear Body (GP) 1pc R0069- Clear Body (EP) 1pc</p> 	<p>R0070- Printed Body (GP) 1pc R0072- Printed Body (EP) 1pc</p> 	<p>R0071- Printed Body (GP) 1pc R0073- Printed Body (EP) 1pc</p> 
<p>R0074- Printed Body (EP) 1pc</p> 	<p>R0075-Buggy Tail Wing (Black) 1pc R0076-Buggy Tail Wing (Brown) 1pc R0077-Buggy Clear Tail Wing 1pc</p> 	<p>85274-Li-Po 2700mAh 7.4V 1pc</p> 	<p>10253 - 1/10 Charger CE 1pc 10254 - 1/10 Charger UL 1pc 10255 - 1/10 Charger BS 1pc</p> 

