

INSTRUCTION MANUAL

1/10 Electric Sand XL Buggy



NO.RH1043

OCTANE EBD

NO.RH1045

OCTANE EBL

VRX Racing RTR Brushed 2.4GHz Truck/Buggy

Congratulations on your purchase of the VRX Racing 4WD electric cars.

This 1/10th scale model has been factory assembled and all electrics installed and set up to make it the easiest possible introduction to the sport of driving RC cars.



WARNING: Read the ENTIRE instruction manual to become familiar with the features of the product before operating. Failure to operate the product correctly can result in damage to the product, personal property and serious injury. This is not a toy and must be operated with caution and common sense. Failure to operate this product in a safe and responsible manner could result in damage, injury or damage to other property. This product is not intended for use by children without direct adult supervision. It is essential to read and follow all the instructions and warnings in the manual, prior to assembly, set-up or use, in order to operate correctly and avoid damage and serious injury.

Safety Precautions and Warnings

You are responsible for operating this model such that it does not endanger yourself and others, or result in damage to the product or the property of others. This model is controlled by a radio which is possibly subject to interference which can cause momentary loss of control so it is advisable to always keep a safe distance to avoid collisions and injury. Age Recommendation: 14 years or over. This is not a toy. This product is not intended for use by children without direct adult supervision.

Carefully follow these directions and warnings, plus those any additional equipment associated with the use of this model, chargers, ESC and motors, radio etc.

- Never operate your model with low transmitter batteries.
- Always operate your model in an open area away from cars, traffic or people.
- Never operate the model in the street or in populated areas.
- Always keep the vehicles in direct line of sight, you cannot control what you cannot see!
- Keep all chemicals, small parts and anything electrical out of the reach of the children.
- Avoid water exposure, moisture causes damage to electronics and may result in the loss of control or permanent damage.
- Avoid injury from high speed rotating parts, gears and axles etc.
- Novices should seek advice from more experienced people to operate the model correctly and meets its performance potential.
- Exercise caution when using tools and sharp instruments.
- Do not put fingers or any objects inside rotating or moving parts.
- Take care when carrying out repairs or maintenance as some parts may be sharp.
- Do NOT touch equipment such as motor electronic speed control and battery, immediately after using your model because they can generate high temperatures.
- Always turn on your transmitter before you turn on the receiver in the car. Always turn off the receiver before turning your transmitter off.
- Keep the wheels of the model off the ground, keep your hands away from the wheels when checking the operation of the radio equipment.
- Prolong motor life by preventing overheat conditions. Undue motor wear can result from frequent turns, rapid change of direction forwards/backwards, continuous stop/starts, pushing/pulling objects, driving in deep sand and tall grass, or driving continuously up hill.

Required equipment for operation

1. Tools required for building and maintenance:



● Hobby knife



● Precision ruler



● Needle nose pliers



● Lexan scissors



● Flat and Phillips screwdriver

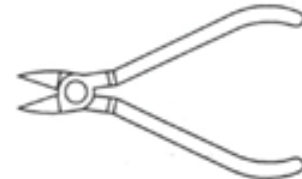

● Wire cutters

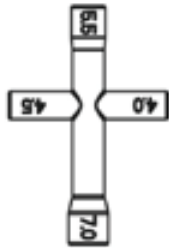

● Cross wrench

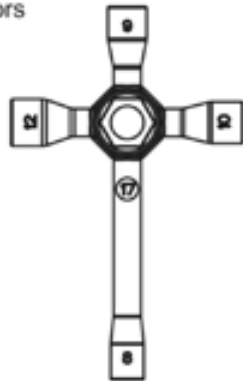

● Cross wrench



● CA glue&rubber cement



● Thread locking compound



1.5mm



2.0mm



2.5mm

● Hex wrench

WARNING!

Do not use a power screw driver to install screws into nylon or plastic materials. The fast locking may heat up the screws being installed that may break the molded parts or strip the threads during installation.

2. Additional items needed for operation:



8 pcs AA Alkaline batteries for transmitter

IMPORTANT!

Check that all screws and nuts are tight before each use.

Aerial Assembly

As the aerial wire on 2.4GHz system is so short you do not need to protrude through the body shell and it can be left to stand directly from the receiver. If you want the security of an aerial tube away simply cut it short, and insert in the usual way but do NOT bend over the last 5mm of aerial wire to retain it under the rubber cap, last two inches of aerial wire need to be straight with no kinks for maximum range and control with 2.4GHz system.

First be sure to insert the wire up through the receiver cover hole as below. Push the wire all the way through the aerial tube until the first 5mm of wire shows out of the other end. Finally make aerial tube firmly seated.

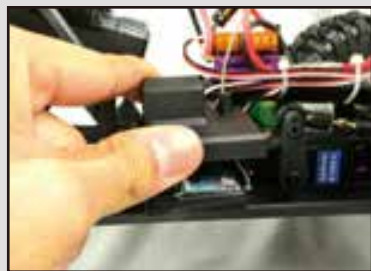

Octane Brushless

Charging/Installing the Battery.

Always store your model with the battery pack unplugged and removed. Always charge your battery away from the vehicle.

WARNING! NEVER LEAVE THE BATTERY UNATTENDED WHILE ON CHARGE.

The supplied charger can charge either 2s or 3s (cell number) Lipo batteries. The supplied battery is a 2s ensure you plug it into the correct 2s balance port.

When the charger is connected to the mains powers the power LED will turn green. Once you connect your balance connector to the charge the status LED will turn red indicating that charging is in progress. Once the battery is fully charged the status LED will turn green. If you experience the LED blinking red then there is an error with either the battery or charger.

When charging a completely discharged battery, the charger can become hot to touch. NEVER LEAVE THE BATTERY CHARGE UNATTENDED. Always disconnect the charger from the mains supply and the battery pack when not in use.

To install a charged battery, firstly remove the body shell and insert the battery into the battery case, then fasten the two Velcro straps to fix the battery stably. When connecting battery and turning car on, ensure it is off ground with wheels away from objects.



Octane Brushed

Charging/Installing the Battery.

Always store your model with the battery pack unplugged and removed. Always charge your battery away from the vehicle. The included 300mAh mains charger will take approx 6 hours to charge a fully discharged battery, but always remove it from the charger if it becomes warm to the touch. Always disconnect the charger from the mains supply and the battery pack when not in use. Keep children away from charger and battery during the charging process.

To install a charged battery, firstly remove the body shell and insert the battery into the battery case, then fasten the two Velcro straps to fix the battery stably. When connecting battery and turning car on, ensure it is off ground with wheels away from objects.



Notes on Battery use:

Always allow the battery cool after use, before recharging.

Always inspect the battery before charging.

Any bare wires, split heat shrink or leakage is a sure sign of abuse.

Never attempt to charge dead or damaged batteries.

Do not disassemble the battery or cut the connector wires.

If the battery connector, battery case or cable insulation get hot enough to melt or split there is most likely a serious problem with your model, battery wires or speed controller. Find and correct the problem before installing another charged battery pack.

NEVER charge the battery unattended in case of overcharging, you need to be able to monitor the battery during charging.

Charge away from flammable objects and on a non-flammable surface in case the battery becomes too hot.

Getting Started

Refer to 2.4ghz binding manual for radio set-up.

Switch on transmitter

Hold vehicle clear of the ground,connect battery pack and switch on receiver.

Test the transmitter to check control of the vehicle with wheels off the ground.

Start driving slowly and if the vehicle does not go straight ,adjust steering trim dial on Transmitter.

For the very first run use the throttle gently,to help the driver become accustomed to the vehicles behaviour and controls.

Although this vehicle features waterproof electronics they are not designed to be submerged in water.Potential damage can still occur to vehicles components if you do so.

After Run.

Switch off the receiver power,switch off the transmitter.Disconnect the battery and remove it from the vehicle,allow it to cool before recharging.If you have a second charged battery all ready to use,still allow the vehicle to cool slightly before continuing.

Regular maintenance.

Frequently check the whole vehicle for loose or missing fixings.Use thread lock on any replacement screws into metal threads.

Frequently check rotating parts are free from grass,string etc.that might bind their motion and over stress the motor or speed controller.Remove the wheels occasionally and check behind the mounting hex for obstructions or anything that might have been wrapped around the axle and caused extra drag.

Check the gear mesh frequently and remove any stones or grit from gear teeth to prevent premature wear and damage.

If the motor moves,or is removed for maintenance/exchange,the gear mesh will need to be set.Simply slacken the motor retaining screws and adjust the motor until there is just disceable backlash between pinion and spur teeth.If the gear is too tight or too loose the gears will be noisy and could be damaged.

Shock absorbers will wear prematurely if used in dirty dusty conditions.Replace oil and seals as required to keep a smooth dampening action.



Trouble shooting guide.

Short Runtime:
Battery damaged/not charged.

Motor dirty or brushes worn.
Drivetrain binding.

Sluggish Action:
Motor damaged.
Bind in drive train.
Battery running low on power.

Motor/ESC overheat:
Over-gearred
Binding transmission.
Seized axle bearing.
Motor binding.

Motor spins but vehicle refuses to move:
Gears damaged.
Gears loose on shaft.
Magnets debonded from motor armature.
Slipper clutch too loose.
Drive shaft broken or missing.

Poor Range or fails to operate:
Transmitter batteries low.
Vehicle Battery Low.
Transmitter switched off.
Transmitter/receiver aerial not extended.
ESC switched off or battery not connected.
Loose connectors/wires.
2.4ghz binding with -receiver lost

LIPO BATTERY-USER SAFETY AND HANDLING INSTRUCTIONS.

Read all safety instructions before charging or using your batteries for the first time.

Lipo batteries require completely different charging and care than Nicd and NIMH batteries. Misuse can result in fire, personal injury and/or damage to property. The buyer assumes all Liability and risk associated with the use of Lithium-Polymer (Li-Po) batteries. Immediately return the battery, unused, if you do not agree with these terms.

General guidelines and warnings:

1. Use a Lithium Polymer specific chargers only! Do not use a NiCd or NiMH charger.
2. NEVER charge unattended. Always charge in safety sack or metal tin with lid and away from other flammable materials.
3. During the charge process watch for swollen or ballooning cells. If this happens immediately disconnect the charger and move the battery to a fire proof place for 15 minutes. Do not attempt to charge again.
4. A short circuit can cause a rapid discharge of high currents. Avoid short circuits, and be aware of short circuits on jewelery.
5. Any Lithium Polymer battery involved in a crash should be removed and observed in a fireproof space for 15 minutes before continuing to use or charge the battery.
6. If rewiring the battery pack, rewire the leads one at a time. Do not cut both leads. Do not short circuit on tools.
7. Do not expose battery packs to direct sunlight for extended periods.
8. Do not attempt to tamper with or open the LiPo Hardcase. The case is protection against possible battery swelling.

Before charging:

Visually inspect the pack checking for damaged leads, connectors, cracked heat shrink covering, swelling or other abnormalities. Do not charge if the pack is damaged.

Charging process:

1. NEVER charge unattended.
2. Charge away from flammable materials and inside a Lipo safe sack or metal tin with lid.
3. Allow battery to cool before charging.
4. Use the battery label for setting charger cell count and voltage.
5. Do not exceed 5C MAX charge rate. (Example, charge a 1000mAH pack at 5A MAX)

If disposing of a Lipo battery proceed as follows:

Submerge the battery into a container filled with about 10 litres of salt water (one cup of salt in 10L). Leave the battery submerged for 2 weeks, this will slowly and safely discharge the battery until the voltage has dropped to zero volts which eliminates the risk of any chemical reaction. It can then be disposed off in the general waste collection.

Front Shocks

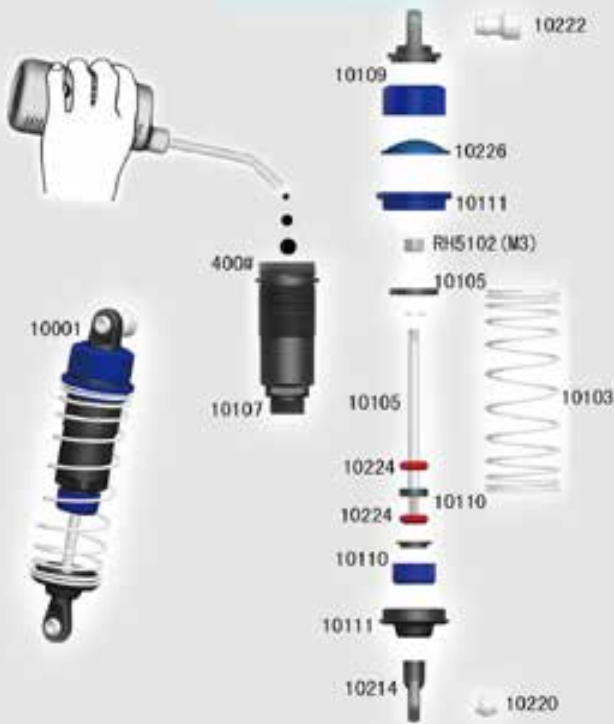

(Dia. 1-1)

Rear Shocks

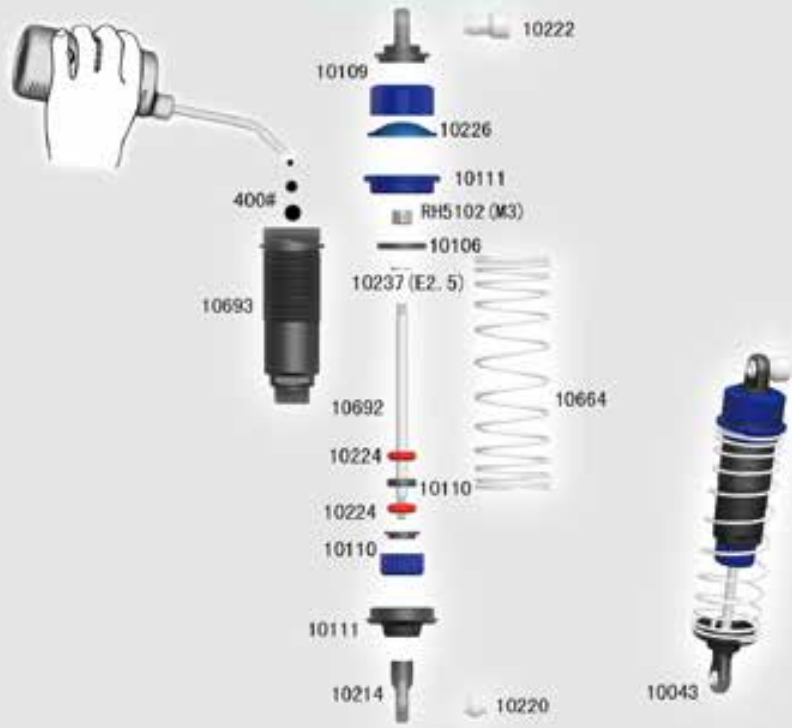

(Dia. 1-2)

Front Differential

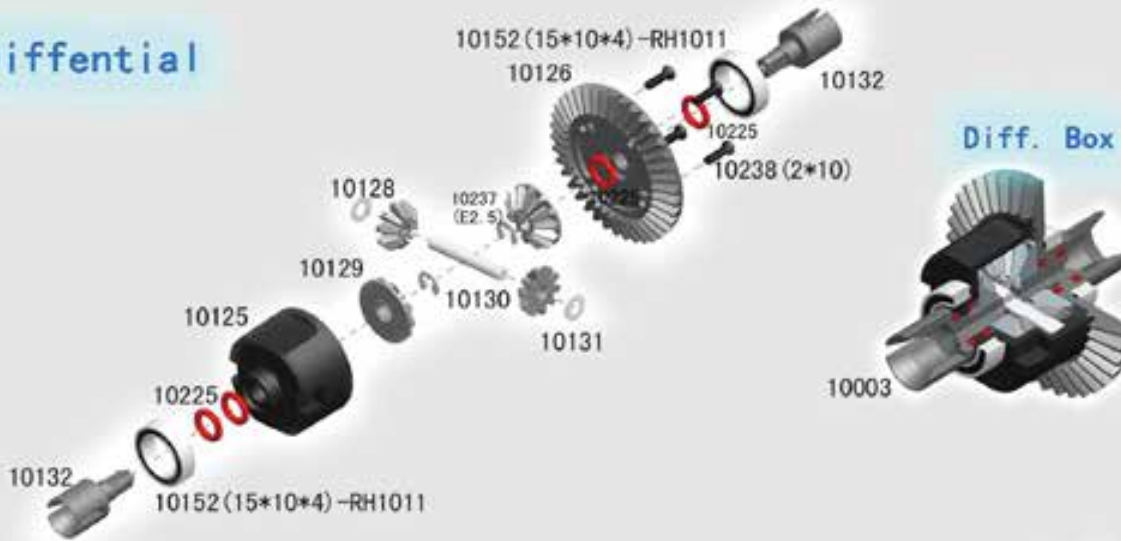

(Dia. 2-3)

Front Gearbox Assembly



B O M

TYPE	ITEM	SPEC	QTY
Round Head Self Tapping Hex Screw	10241	M3*10	4
Button Head Hex Screw	8040	M3*12	2
	8042	M3*12	2
	8043	M3*12	2
Cap Head Hex Screw	8040	M3*10	4
	8042	M3*12	2
Flat Head Hex	8040	M3*12	10
	8042	M3*12	2
	8043	M3*12	2
Set Screw	8049	M3*10	1
	80410	M3*10	2
Ring Self Tapping Screw	10247	M3*8	2
Rubber	10001	46.0mm	2
Nylon Lock Nut	85125	M3*10	2
E-clip	10221	M3*10	1
O-Ring	10681	RH5116 (3*3)	1
Ball Bearing	10201	17T	1

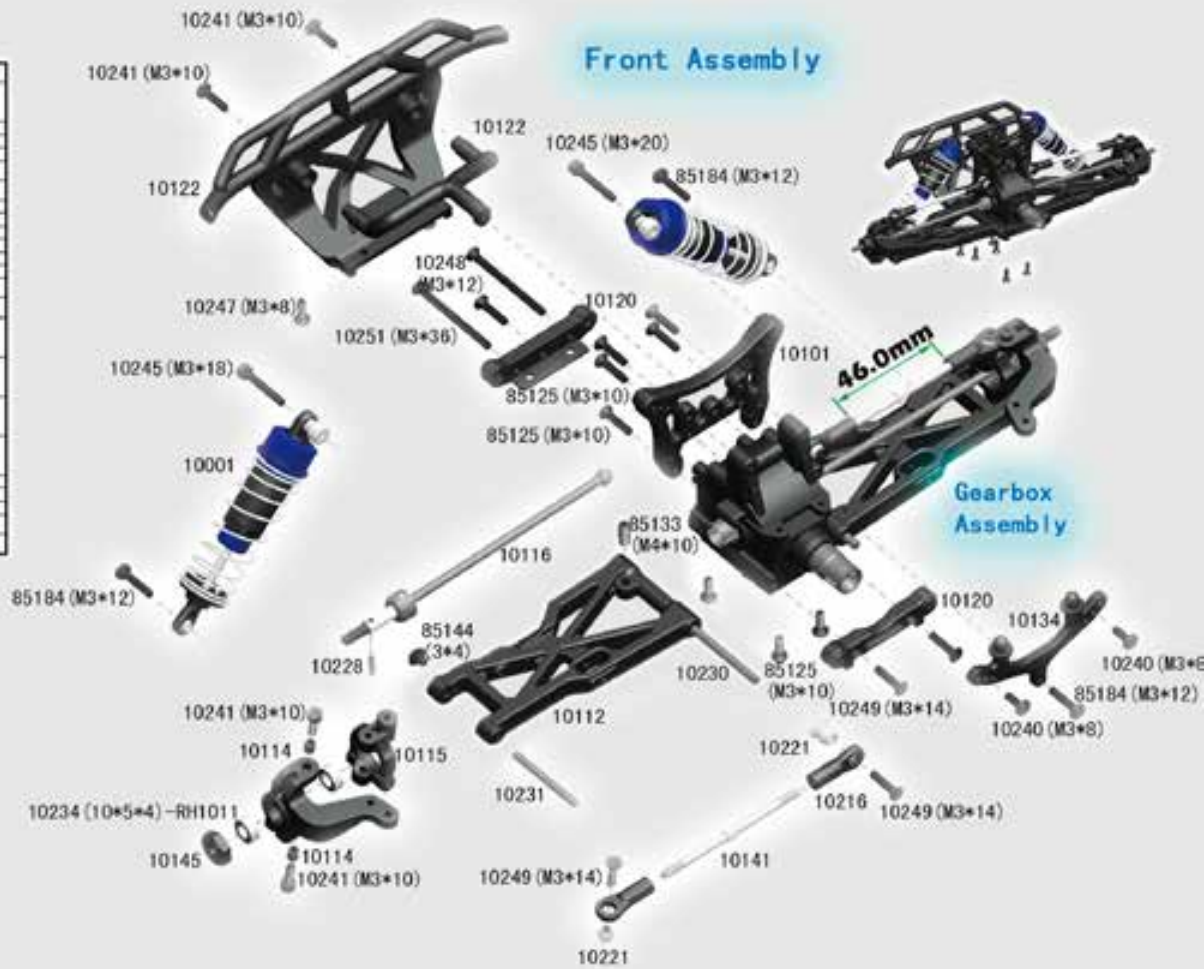

(图 2-1)

Steering Assembly



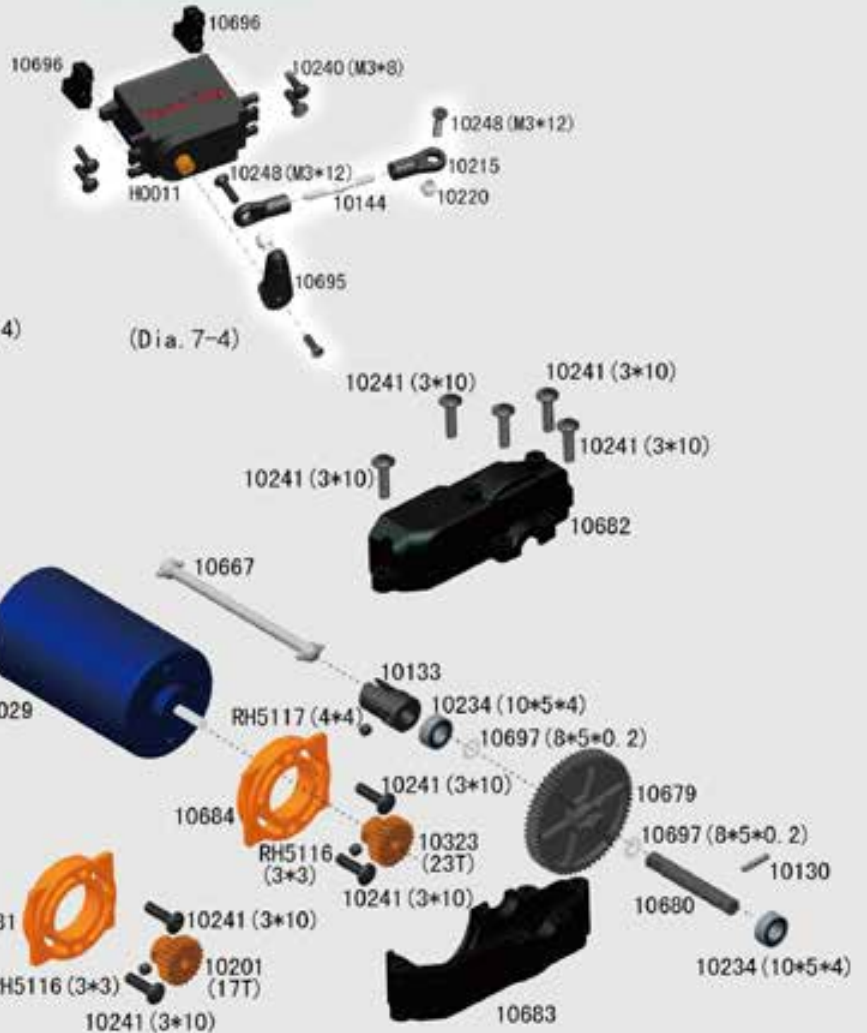
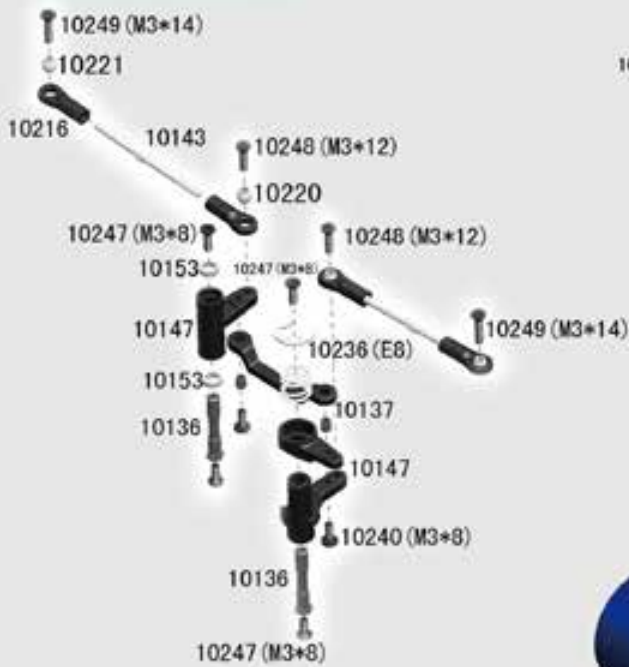









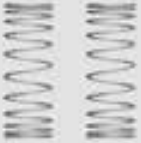
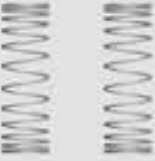

Servo Assembly



Central Transmission















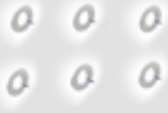









Part List

The pictures are for reference only, please refer to actual object.

<p>10101 - Front Shock Tower 1pc</p> 	<p>10001-Front Shocks 2pc</p> 	<p>10043 - Rear Shock Tower 2pc (Al)</p> 	<p>10103-Front Shock Spring 2pc</p> 
<p>10664-Rear Shock Spring 2pc</p> 	<p>10105-Front Shock Shaft & Piston Set 2sets</p> 	<p>10692-Rear Shock Shaft & Piston Set 2sets</p> 	<p>10107-Front Shock Body 2pc</p> 
<p>10111-Shock Lower holder & Adjust Ring 2sets</p> 	<p>10693-Rear Shock body 2pc (Al)</p> 	<p>10109-Shock Upper Cap 2sets</p> 	<p>10110-Shock Lower Caps 2sets</p> 
<p>10112-Front Lower Susp. Arm 2pc</p> 	<p>10114-Steering Knuckle Arm 1set</p> 	<p>10115-Uprights 2pc</p> 	<p>10116-Front CVD 2pc</p> 
<p>10120-Front Susp. Holders 2pc</p> 	<p>10122-Bumper 1Set</p> 	<p>10123-Gearbox Housing Set 2pcs</p> 	<p>RH5526-Diff 16T Gear Washer 6pcs</p> 
<p>10124-Diff. Drive Gear w/pin 2sets</p> 	<p>10003-Diff Gearbox Set 1set</p> 	<p>10125-Diff Case 2pcs</p> 	<p>10126-Diff Drive Spur Gear 2pcs</p> 

Part List

The pictures are for reference only, please refer to actual object.

<p>10127-Diff Drive Gear 2pcs</p> 	<p>10128-Diff Bevel Gear S. 4pcs</p> 	<p>10129-Diff Bevel Gear B. 4pcs</p> 	<p>10130-Diff Pin 2pcs</p> 
<p>10131-Washer 6pcs</p> 	<p>10132-Diff Drive Cup 4pcs</p> 	<p>10133-Center Coupler 3pcs</p> 	<p>10134-Body Post 2pcs</p> 
<p>10135-Servo Saver (GP) 1set</p> 	<p>10136-Servo Saver Post 2pcs</p> 	<p>10137-Steering Ackerman</p> 	<p>10141-Front Upper Susp. Arm 2sets</p> 
<p>10143-Steering Arm 2sets</p> 	<p>10144-Servo Linkage 1pc</p> 	<p>10145-Wheel Hub 4pcs</p> 	<p>10146-Antenna Pipe Set 2sets</p> 
<p>10147-Servo Saver (EP) 1set</p> 	<p>10152-Metal Bushing 15*10*4 6pc</p> 	<p>10153-Metal Bushing 8*5*2.5 6pc</p> 	<p>10695-Servo Horns</p> 
<p>10696-Servo Post 2sets</p> 	<p>10201-Pinion Gear 17T(EP) 1pc</p> 	<p>85034-Body Clip(Medium Size)6pcs</p> 	<p>85029-Body Clip(Small Size) 6pcs</p> 

Part List

The pictures are for reference only, please refer to actual object.

<p>10652 Roll cage Top Frame</p> 	<p>10653 Roll cage side Frame 2pcs</p> 	<p>10654 Roll cage Front 1pc</p> 	<p>10655 Roll cage rear plate 1pc</p> 
<p>10656 Rearlink holder</p> 	<p>10657 Rear Central CVD rear half</p> 	<p>10658 Spare wheel support</p> 	<p>10659 Roll cage window frame 1pc</p> 
<p>10660 Rearaxle housing</p> 	<p>10661 Rear axle cover</p> 	<p>10662 Axle adaptor 2pcs</p> 	<p>10663 Rear holder for rear shock support rod 2pcs</p> 
<p>85284 Battery case</p> 	<p>10665 Rear link set 2pcs</p> 	<p>10666 Upper plate</p> 	<p>10667 Front central drive shaft 1pc</p> 
<p>85286 Velco Tape 2pcs</p> 			
<p>10668 RX cover</p> 	<p>10669 Rear drive Shaft short 1pc</p> 	<p>10670 Rear drive Shaft long 1pc</p> 	<p>10671 Front holder for Rear shock support rod 2pcs</p> 
<p>10672 Sway bar</p> 	<p>10673 Battery case holder 2pcs</p> 	<p>10674 Main frame 2pcs</p> 	<p>10675 Rear shocks lower Support Rod 2pcs</p> 

























Part List

The pictures are for reference only, please refer to actual object.

<p>10676 Chassis plate</p> 	<p>10677 Sway bar pull rod upper</p> 	<p>10678 Sway bar pull rod lower</p> 	<p>10679 Main gear 62T 1pc</p> 
<p>10680 Central drive shaft</p> 	<p>10682 Central transmission cover upper</p> 	<p>10683 Central transmission cover lower</p> 	<p>10681 Motor mount (For 17T) 1PC</p> 
<p>10684 Motor mount (For 23T) 1PC</p> 	<p>10685 Rear central CVD front half</p> 	<p>10332 Rim 2pcs</p> 	<p>10686 Tyres & foam 2sets</p> 
<p>10687 Preassembled Tyres 2sets</p> 	<p>R0224 Printed body (Blue)</p> 	<p>R0226 clear body</p> 	<p>R0225 Printed body (Black)</p> 
<p>10688 Driver helmet 2pcs</p> 	<p>10689 Driver Blister set w/decals</p> 	<p>10690 Rear diff shaft 1pc</p> 	<p>10323 pinion gear 23T 1pc</p> 
<p>10691 Ball bearing (11*5*4mm) 6pc</p> 	<p>10697 Washer (8*5*0.2mm) 6pc</p> 	<p>10214-Shock Ball End 6pcs</p> 	<p>10700-Ring Self Tapping Screw 2.5*3 4pc</p> 





















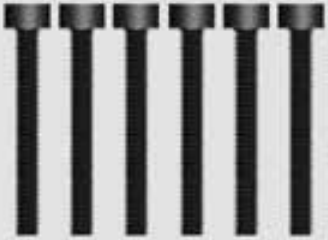
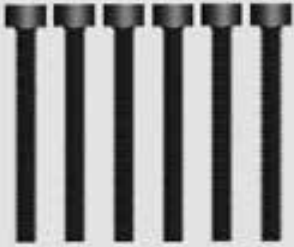

Part List

The pictures are for reference only, please refer to actual object.

<p>10215-Servo Link Ball End 6pcs</p> 	<p>10216-Steering Linkage Ball End 6pcs</p> 	<p>10220-Ball A 6pcs</p> 	<p>10221-Ball B 6pcs</p> 
<p>10222-Ball C 6pcs</p> 	<p>10224-Shock O-ring (Lower) 6pcs</p> 	<p>10225-Diff O-ring Seal 6pcs</p> 	<p>10226-Shock seal cover 4pcs</p> 
<p>10228-Pin f 2*10 6pcs</p> 	<p>10230-Hinge Pins (long & short) 2sets</p> 	<p>10232-Ball Bearing 15*10*4 6pcs</p> 	<p>10233-Ball Bearing 10*5*4 6pcs</p> 
<p>10234-Metal Bushing 10*5*4 6pcs</p> 	<p>10235-Ball Bearing 8*5*2.5 6pcs</p> 	<p>10236-E clip-8mm 4pc</p> 	<p>RH5190-E clip-4mm 6pc</p> 
<p>10237-E clip-2.5mm 6pc</p> 	<p>RH5102-Nylon Lock Nut M3 6pc</p> 	<p>RH5103-Nylon Lock Nut-M4 6pc</p> 	<p>85148-Round Head Self Tapping Hex Screw 2*6 4pcs</p> 
<p>10238-Round Head Self Tapping Hex Sorew 2*10 6pc</p> 	<p>85179-Round Head Self Tapping Hex Screw 3*15 8pc</p> 	<p>10239-Round Head Self Tapping Hex Screw M3*6 6pc</p> 	<p>10240-Button Head Hex Screw M3*6 6pc</p> 





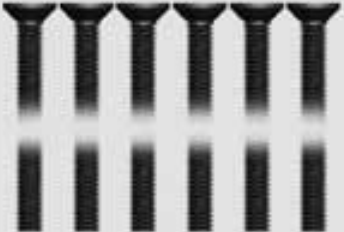

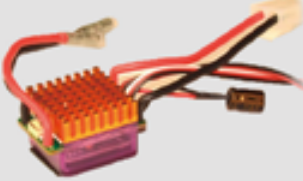

Part List

The pictures are for reference only, please refer to actual object.

10241-Button Head Hex Screw M3*10 6pc 	85184-Button Head Hex Screw M3*12 6pc 	10242-Button Head Hex Screw M3*14 6pc 	85144-Ring Self Tapping Screw 3*4 4pc 10256-Ring Self Tapping Screw 3*6 6pc 
RH5116-Set Screw M3*3 6pc 	RH5117-Set Screw M4*4 6pc 	85133-Button Head Hex Screw M4*10 6pc 	10699-Set Screw M3*10 6pc 
RH5562-Cap Head Hex Screw M3*8 6pc 	10243-Cap Head Hex Screw M3*10 6pc 	85182-Cap Head Hex Screw M3*10 6pc 	10244-Cap Head Hex Screw M3*14 6pc 
85118-Cap Head Hex Screw M3*15 6pc 	10245-Cap Head Hex Screw M3*18 6pc 	85185-Cap Head Hex Screw M3*25 6pc 	10246-Cap Head Hex Screw M3*28 6pc 
10698-Flat Head Hex M3*6 6pc 	10247-Flat Head Hex M3*8 6pc 	85125-Flat Head Hex Screw M3*10 6pc 	10248-Flat Head Hex Screw M3*12 6pc 
10249-Flat Head Hex Screw M3*14 6pc 	85127-Flat Head Hex Screw M3*18 3pc 	10250-Flat Head Hex Screw M3*20 6pc 	10251-Flat Head Hex Screw M3*36 6pc 













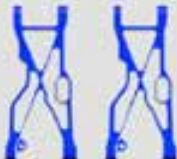

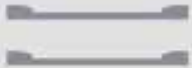





Part List

The pictures are for reference only, please refer to actual object.

<p>H0050-400A ESC 1pc</p> 	<p>H0028 - 3650 300KV Motor 1pc</p> 	<p>H0029 - 550 Brushed Motor 1pc</p> 	<p>H0030 - Ni-MH 7.2V 1800mAh 1pc H0031 - Ni-MH 7.2V 3000mAh 1pc</p> 
<p>H0011 - 3kg/cm Servo 1pc</p> 	<p>85274-Li-Po 3250mAh 7.4V 1pc</p> 	<p>10253 - 1/10 Charger CE 1pc 10254 - 1/10 Charger UL 1pc 10255 - 1/10 Charger BS 1pc</p> 	<p>H0072 - 45A KS Brushless ESC H0082 - 60A KS Brushless ESC</p> 
<p>10694-Pin ϕ 2*13 6pcs</p> 			

Upgrade Part List

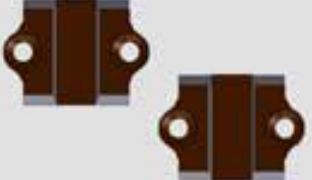
The pictures are for reference only, please refer to actual object.

<p>10902 - Front Shock Plate (Carbon) 1Set</p> 	<p>10907-Front Shocks (AL) 2pc</p> 	<p>10909 - Front Lower Susp. Arm (AL) 2pc</p> 	<p>10911 - Steering Ackerman (AL) 1pc</p>  <p>10912 - Front Susp. Holders (AL) 1Set</p> 
<p>10994 - Battrey case holder (Al)</p> 	<p>10917 - Steering Knuckle Arm (AL) 2Set</p> 	<p>10918 - Wheel Hub (AL) 4pc</p> 	<p>85265 - Heatsink 1pc</p> 
<p>10923 - Alum Steering Arm 2pc</p> 	<p>10975 - Alum Motor mount (For 17T) 1pc</p> 	<p>10976-AL Motor mount (For 23T) 1pc</p> 	<p>10977-Chassis plate (Al) 10992-Chassis plate (carbon) 1pc</p> 
<p>10924 - Alum Knuckle Arm 2pc</p> 	<p>10978-Swearbar pull rod upper (Al) 2pc</p> 	<p>10979-Swearbar pull rod lower (Al) 2pc</p> 	<p>10980-Rear Central CVD Front half (steel) 1pc</p>  <p>10981-Front holder for Rear Shock Support rod (Al) 2pos</p> 
<p>10982-Rear Shocks lower Support rod (Al)</p> 	<p>10983-Main frame (Al) 2pos</p> 	<p>10984-Rear link holder (Al)</p> 	<p>10985-AL rear link set 2pos</p> 
<p>10986-Axle adaptor (Al)</p> 	<p>10987-Upper plate (Al)</p> 	<p>10988-Rear AXle housing (Al)</p> 	<p>10991-Rear holder for rear shock support rod (Al)</p> 
<p>10989-Alum rear Axle</p> 	<p>10993-Alum Rim 2pos</p> 	<p>H0096-Headlight (plastic frame)</p> 	<p>H0097-Headlight (Alum frame)</p> 